



# Operating Manual

for

# *StoreX*

**Precision Incubator  
Series**

*STX40, STX100, STX200, STX500, STX1000*  
*IC, HC, HR, DC, DR, DF*  
*SA, BT, IT*

## Important Notice

© 1993-1995, 1995-1999, 2000, 2001, 2002, 2008, 2013, 2018, 2020 LiCONiC AG Liechtenstein, all rights reserved.

The Information contained in this document is subject to change without notice.

Information provided by LiCONiC AG is believed to be accurate and reliable. However, the user is responsible for the proper and correct use of the product. No license is granted by acquisition of the product for any patent or patent rights of LiCONiC. If the user does not follow the instructions given in this manual, LiCONiC does not take any responsibility for injuries or damages caused by the LiCONiC product.

## Contact Address

LiCONiC AG  
Industriestrasse 8  
FL - 9493 Mauren  
Principality of Liechtenstein

Telephone: +423 373 63 39  
Telex: +423 373 53 59  
E-mail: [info@liconic.com](mailto:info@liconic.com)  
Internet: [www.liconic.com](http://www.liconic.com)

***Before operating the instrument, the user must read and understand this manual.***

## Installation and Servicing

Installation, servicing and reinstallation of the instrument shall only be performed by System Integrators and / or service personnel authorized by LiCONiC AG.

LiCONiC regularly offers Operator Training Courses. We highly recommend the attendance of such a course prior to working with a LiCONiC Instrument.

# Table of Contents

<b>1.</b>	<b>About the Product and its Manual .....</b>	<b>6</b>
1.1	Intended Use .....	6
1.2	Unintended Use .....	6
1.3	Product Identification .....	6
1.4	Scope of Delivery .....	6
1.5	General .....	6
1.6	Definitions .....	7
1.7	Target User Group .....	7
1.8	Importance of the Safety Instructions .....	7
1.9	Labels .....	7
1.10	Safety - Basics .....	8
1.11	General Safety Regulations .....	8
1.12	Glossary of symbols on equipment and explanations .....	9
<b>2.</b>	<b>The StoreX Incubator Family .....</b>	<b>10</b>
2.1	StoreX Instruments .....	10
2.2	LiCONiC StoreX Features .....	10
2.3	StoreX Configuration and Capacity Overview .....	11
2.4	LiCONiC StoreX Climate Overview .....	12
2.5	The StoreX 40 Handler .....	13
2.6	The StoreX Carrousel Handler .....	14
<b>3.</b>	<b>Options .....</b>	<b>15</b>
3.2	StoreX Climate Options .....	15
3.3	StoreX Configurations .....	15
3.4	RH-Option .....	17
3.5	Gassing Options .....	18
3.6	UHS (Ultra High Speed) Option .....	21
3.7	Customized Color .....	21
<b>4.</b>	<b>Accessories .....</b>	<b>22</b>
4.1	STX Stackers .....	22
4.2	STX Transfer Stations .....	23
4.3	Slide Station .....	25
4.4	Lift Station .....	25
4.5	Shuttle Station .....	26
4.6	Bar Code Reader .....	28
4.7	Scheduler .....	29
<b>5.</b>	<b>Packing and Transport .....</b>	<b>30</b>
5.1	Unpacking the Instrument .....	30
<b>6.</b>	<b>Installation of the Instrument .....</b>	<b>32</b>
6.1	Transfer Station Position .....	35
6.2	Floor Loading Requirements .....	39
6.3	Electrical Connections .....	40
6.4	Communication Connections .....	41
6.5	Gassing Installation .....	43
6.6	About other Hazardous Substances .....	58
6.7	Noise sound level .....	59
<b>7.</b>	<b>Manual Operation .....</b>	<b>60</b>
7.1	Routine Safety Checks .....	60
7.2	Front Door .....	61
7.3	Glass Door .....	62
7.4	Stackers .....	63
7.5	Bar Code Reader .....	66

7.6	The Robot Gate .....	66
7.7	Humidity Reservoir .....	67
7.8	Power-On System.....	68
7.9	Alarm System .....	69
7.10	Temperature Settings.....	69
7.11	Cleaning.....	70
7.12	Disinfecting .....	70
7.13	Defrost.....	70
<b>8.</b>	<b>Remote Operation.....</b>	<b>71</b>
8.1	RS-232 Serial Port Configuration .....	71
8.2	Communication Fundamentals .....	71
8.3	TCP / IP Server Interface (Java).....	73
8.4	StoreX Network Communication .....	74
<b>9.</b>	<b>Utility Software.....</b>	<b>78</b>
<b>10.</b>	<b>Troubleshooting .....</b>	<b>82</b>
<b>11.</b>	<b>Maintenance.....</b>	<b>83</b>
11.1	Maintenance Guidelines.....	83
11.2	Removal of StoreX Handling .....	84
11.3	Lubrication of Handling Components .....	85
11.4	Cleaning.....	85
11.5	Bar Code Scanner .....	86
11.6	Lubrication .....	86
11.7	Belt Tension.....	86
<b>12.</b>	<b>Technical Data .....</b>	<b>87</b>
12.1	Mechanics.....	87
12.2	Electronics .....	87
12.3	Pneumatics .....	87
12.4	Overall Dimensions.....	87
12.5	Weights.....	89
12.6	Ambient Ratings.....	89
<b>13.</b>	<b>Appendix .....</b>	<b>90</b>
13.1	Decontamination instructions .....	90

History Page

Document Change History

<i>Date</i>	<i>Version</i>	<i>Changes</i>	<i>Author</i>
14.06.2018	V7.10	Add Version Control; Update Logo; Update CO2 pressure requirements	Ralf Kindle
26.11.2020	V7.11	Remove Legacy Communication; Add new Standard Communication	Ralf Kindle

# 1. About the Product and its Manual

## 1.1 Intended Use

The LiCONiC StoreX is intended for storage, identification and transfer of Microplates. It is to be applied exclusively in the research field. The LiCONiC StoreX is intended to work as an element in an automated system.

## 1.2 Unintended Use

Due to its open architecture, the LiCONiC StoreX is NOT intended for clinical and diagnostic applications. These applications would be carried out by less qualified people, exposing them to dangerous liquids in the case of instrument malfunction.

Read the safety instructions in this Manual carefully.

## 1.3 Product Identification

The Type Plate is located at the rear of the LiCONiC StoreX

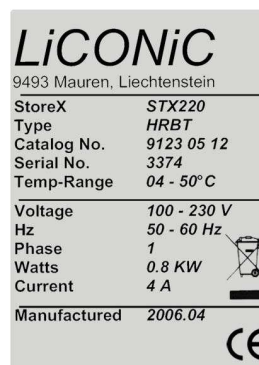

<b>LiCONiC</b>	
9493 Mauren, Liechtenstein	
StoreX	STX220
Type	HRBT
Catalog No.	9123 05 12
Serial No.	3374
Temp-Range	04 - 50° C
Voltage	100 - 230 V
Hz	50 - 60 Hz
Phase	1
Watts	0.8 KW
Current	4 A
Manufactured	2006.04
	

For future reference, please read the instrument Serial No. on the rear of your instrument and write it in the provided space.

## 1.4 Scope of Delivery

- Basic Unit, consisting of the Plate Handling, the Gate and the Incubation chamber
- Product Documents
- Cables
- User Software and Drivers
- Stackers (as specified)
- Transfer Station (as specified)

## 1.5 General

The LiCONiC StoreX is not a complete product for end use. It is delivered exclusively to professional System Integrators who take full responsibility for safe installation and documentation of the entire system.

Do not operate until it has been established that the system, into which the LiCONiC StoreX has been incorporated is in compliance with all local safety regulations.

## 1.6 Definitions

Operator:	Any person who uses the equipment for its intended purpose.
System Integrator:	Authorized person or company responsible for installation, initial start up and overall safety of the system.  Person or company who carries out service and maintenance tasks and is therefore contacted in the case of any problems with the system.

## 1.7 Target User Group

The StoreX has been conceived for applications in the research field, requiring highly qualified and authorized laboratory personnel.

Instrument operation requires thorough knowledge of applications, instrument functions and software programs as well as all applicable safety rules and regulations.

## 1.8 Importance of the Safety Instructions

This chapter contains general information assuring safe operation of the instrument. More specific instructions in regard to safety are given throughout this manual, at the respective points where observation is most important.

Make sure that all Safety Instructions in this publication are strictly followed. If the instrument is used in a manner not specified by the manufacturer, the protection provided by the equipment may be impaired.

## 1.9 Labels

Throughout this publication, Warning Notices are to be interpreted as follows:



**WARNING !**

Indicates the possibility of severe personal injury, loss of life or equipment damage if instructions are not followed.



**CAUTION !**

Indicates the possibility of severe equipment damage if instructions are not followed.



**NOTE !**

Gives helpful information about the equipment.



**DANGER !**

May be harmful to your eyes.

## **1.10 Safety - Basics**

### **1.10.1 General Operating Hazards**

If the equipment is used in a manner not specified by the manufacturer, the protection provided by the equipment may be impaired.

Please carefully observe the following precautions:

### **1.10.2 Mechanical Hazards**

Keep the housing and safety panels closed and never reach into the instrument work space when the unit is in operating mode.

### **1.10.3 Chemical, Biological and Radioactive Hazards**

All samples and test-kit components must be considered as potentially hazardous agents. Therefore, a potential risk may arise from the liquids being handled, such as infectious biological samples, toxic or corrosive chemicals, or radioactive substances. Strictly apply appropriate safety precautions according to local, state and federal regulations.

Prior to any first time application, test runs should be made with a neutral liquid to allow optimization of all liquid handling parameters.

Handling and disposing of waste has to be in accordance with all local, state and federal environmental, health and safety laws and regulations.

Prior to executing any maintenance task on the instrument or sending it, or parts of it for repair, the instrument or the parts have to be thoroughly decontaminated.

## **1.11 General Safety Regulations**

### **1.11.1 Legal Requirements**

Please consult the Manufacturer's Declaration, delivered with each unit by LiCONiC AG, listing all applied directives and standards.

In Europe, the System Integrator must provide a Conformity Declaration upon final installation of the entire system.

### **1.11.2 General Inspection and Maintenance Duties**

Only an authorized System Integrator shall carry out inspection, maintenance and repair tasks.

### **1.11.3 Spare Parts to be used**

Only original LiCONiC Spare Parts may be used. If other parts are used during the normal warranty period, the manufacturer's guarantee may be invalidated.

### **1.11.4 Modifications**

Modifications shall only be carried out by an authorized System Integrator. LiCONiC AG will not accept responsibility for any claim resulting from unauthorized modification or alteration.



## 1.12 Glossary of symbols on equipment and explanations



**WARNING !**  
Areas marked with this label do expect trained personnel accessing.



**Pinch Point**  
Moving parts, keep hands clear.



**Hot Surface**  
Hot Surfaces may be expected, do not touch.



**Laser Hazard**  
Barcode scanner emits class 2 laser according to 21CFR 1040. Avoid direct contact in the laser beam.

## 2. The StoreX Incubator Family

### 2.1 StoreX Instruments

The StoreX Series is the first compact Climate Storage with Integrated Handling that covers the whole range of climates in laboratory applications. The StoreX Series not only covers a wide temperature range, it also offers storage and processes from ultra-dry to extreme humidity. A variety of gas options are available.

The modular mechanical design in combination with extremely simple commands eases the integration of StoreX into any environment. A growing number of accessories are available for the StoreX Series. The combination of environmentally controlled **Storage** and Automatic Plate **Exchange** Capability make StoreX the **Rex** (Latin: king) of storage in laboratory applications.

### 2.2 LiCONiC StoreX Features

All StoreX units have the same compact dimensions. StoreX has a user front door which allows comfortable and easy access for manual operation. The internal glass door allows visual inspection of the content and operation of the system without disturbing the internal climate. Removable stackers make the use of the StoreX even simpler and more efficient. Stackers are available for all common plate types.

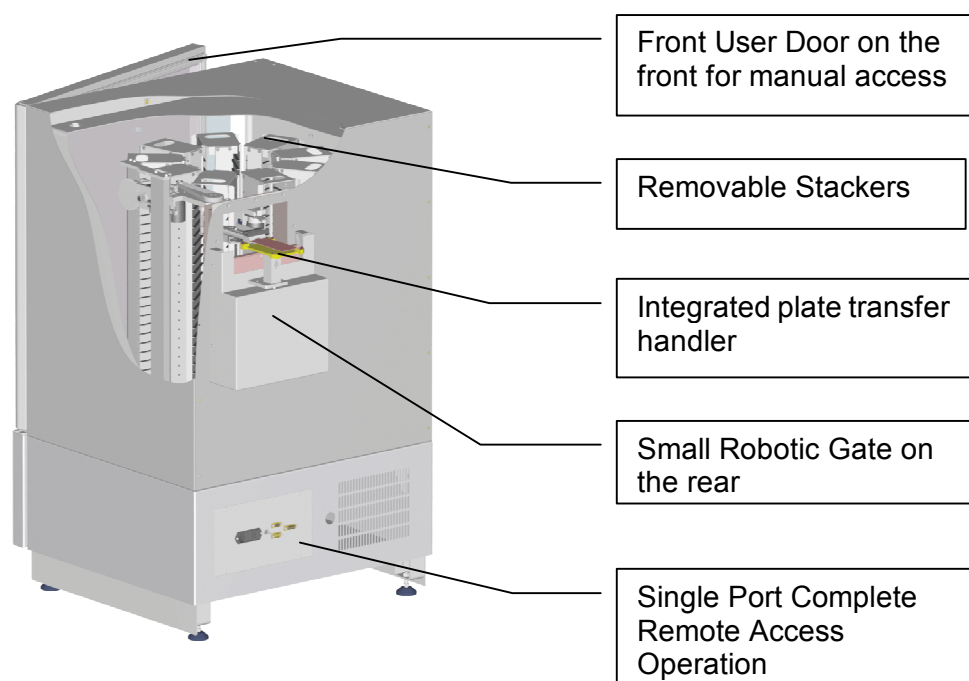

## 2.3 StoreX Configuration and Capacity Overview

The Family of StoreX is structured by their configuration, capacity in Microtiter plates and their climate

Configuration	SA	StandAlone
	BT	BenchTop
	IT	Integrated

StandAlone units are intended for operation on the ground while BenchTop models are for use on a table. The transfer position in SA units is 1000mm high while on BT units it is ~200mm.

Capacity	STX40	44 MTP capacity
	STX100	110 MTP capacity
	STX200	198 MTP capacity
	STX500	250 DWL capacity (530 MTP)
	SXT1000	500 DWL capacity (1060 MTP)

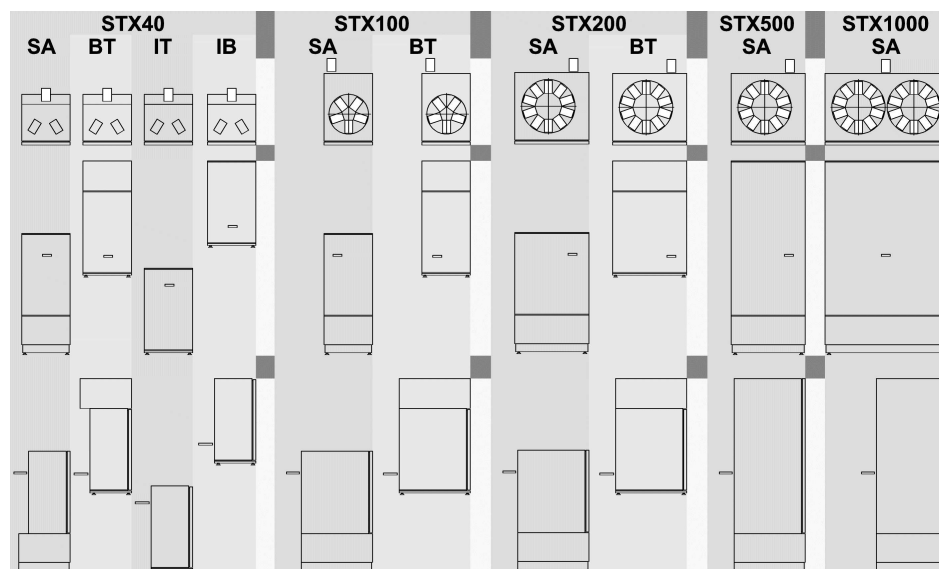

StoreX SA and BT units may be stacked.

## 2.4 LiCONiC StoreX Climate Overview

Climate	IC	Incubator	~33..50°C	>95% RH
	HC	Humid Cooler	04..20°C	90..95% RH
	DC	Dry Cooler	04..20°C	<5%RH
	HR	Humid Range	04..70°C	90..95%RH
	DR	Dry Range	04..50°C	<5%RH
	DF	Deep Freezer	-20°C	

The graphical chart below depicts an overview of the various climate ranges covered by each climate option. The vertical axis shows the relative humidity while the horizontal axis shows temperature. It can be clearly seen that the units cover both extremes: extreme humidity and extreme dryness.

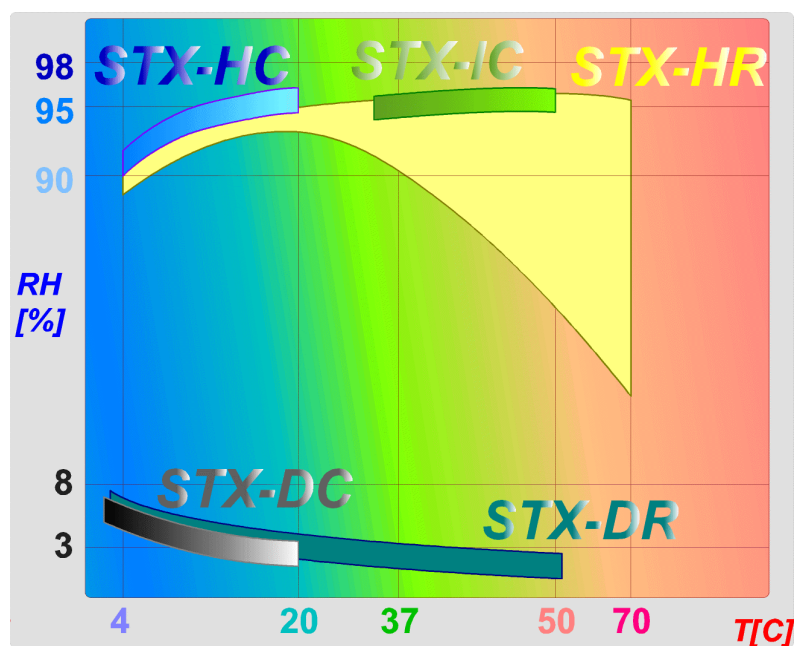

HR-units are Wide Range instruments that cover a wide temperature range. They are a combination, with integrated heater and cooler. Note that all cooled StoreX have an integrated active cooling system. No additional external cooler is needed.

## 2.5 The StoreX 40 Handler

Inside the StoreX climate chamber there is a handling system that allows random transport of plates. Plates can be moved internally as well as transferred to and from the environment. Access times are short and the internal climate is kept stable even for short time periods between accesses.

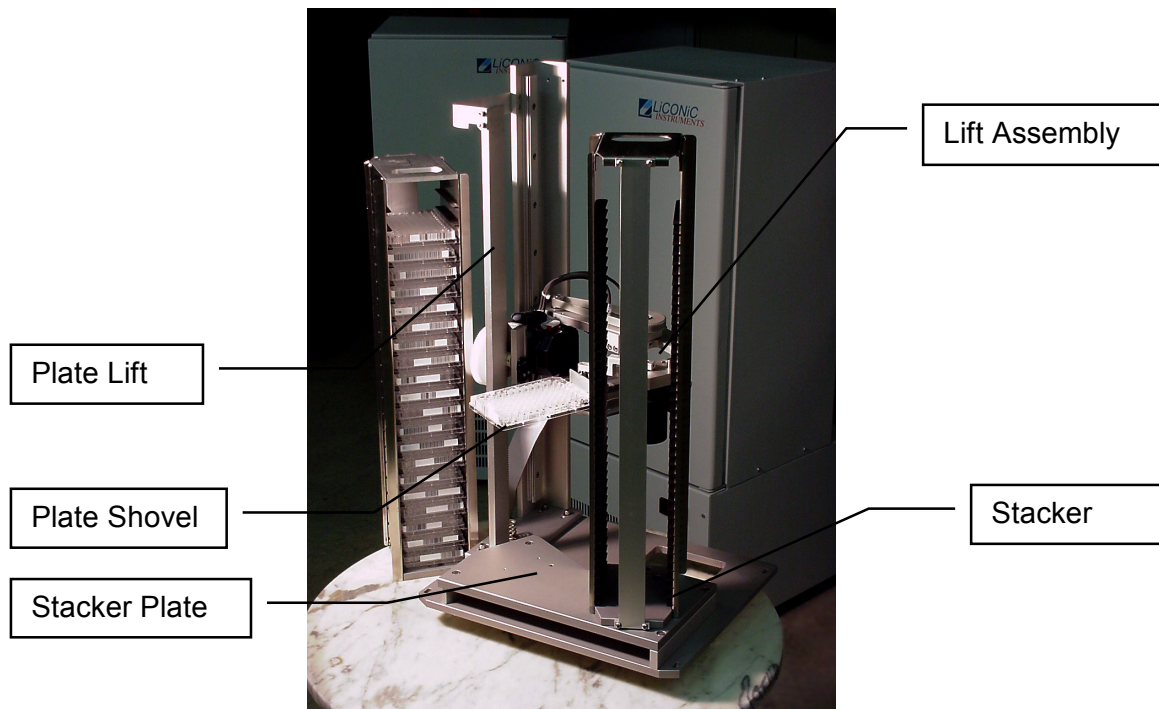

A Handler (4) is used for vertical transport as well as loading and unloading of samples. The Handler consists of a Vertical Positioning Drive (40), a Turn Drive (42) and a Shovel Drive (43). The Handler has a number of vertical positions which are determined by the number of stacker levels and the loading or unloading level.

A Stepper motor is used for vertical positioning of the Handler. All vertical positions are defined by a z-Initiator (15) and the software z-Offset (DM20). The level height is determined by the number of steps of height. The actual travel path to a certain stacker level is calculated by multiplying the level (DM5) by the pitch (DM21) and then adding the z-Offset (DM20). The z-positions of the Transfer Station are stored in Data Memories (DM22, DM24).

The Handler is not only used for vertical transport of the samples, it is also used to pick and place plates in the stackers and to get from, or put plates on the Transfer Station. The pick / place and get / put actions are vertical movements with the extended shovel. Beware of the difference in vertical travel for pick / place movement (DM21), get movement (DM26) and put movement (DM28).

The Turn Drive is used to face the Shovel towards the Transfer Station or towards the desired stacker. The Turn Drive may be positioned at three turn positions. The position at the left stacker is stored in Data Memory DM80, the turn position at the right in Data Memory DM81 and the turn position at the Transfer Station is stored in Data Memory DM82.

The radial Shovel motion is between two hard stops. Force and speed of this drive is controlled by the hardware of the controller card. Speed and force can be adjusted by authorized service personnel.

The correct sequence of motions is monitored by initiators, by detecting the end-positions of motions. Initiators are foreseen for Shovel-In (11) and Shovel-Out Position (12) and Turn Save Range (13).

For save operation, Gate-Open and Gate-Close Positions are detected. The Gate may only be closed when the Turn Save Initiator is active indicating the Handler is turned in.

The Transfer Station is the location where the samples are taken by or put on by the StoreX and the surrounding system. The Transfer Station acts as the common loading / unloading position of the StoreX and the surrounding system. There are several different types of Transfer Stations. This will allow simple integration of the StoreX to any existing system.

## 2.6 The StoreX Carousel Handler

Inside the StoreX climate chamber of higher capacity instruments there is a handling system that includes a positionable carousel thus allowing random access and transport of plates. Plates can be moved internally as well as transferred to and from the environment. Access times are short and the internal climate is kept stable even for short time periods between accesses.

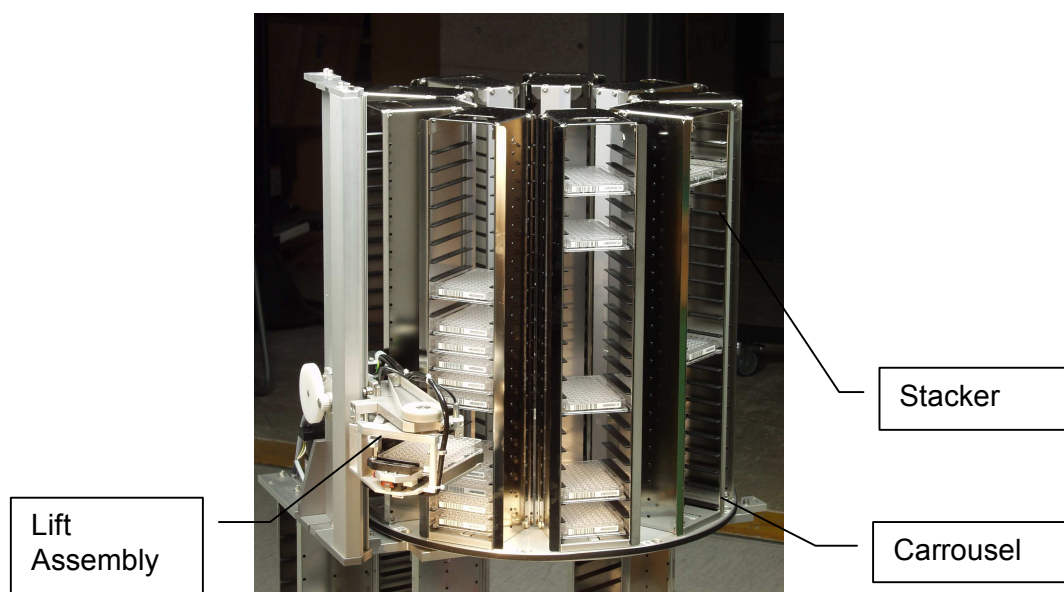

A Handler is used for vertical transport as well as loading and unloading of samples. The Handler consists of a Vertical Positioning Drive, a Turn Drive and a Shovel Drive and a Rotating Drive. The Handler has a number of vertical positions which are determined by the number of stacker levels and the loading or unloading level.

## 3. Options

### 3.1.1 Overview

The LiCONiC StoreX is available with a wide selection of options. By choosing the right options the StoreX can be optimized for almost all known applications. The range of options is continuously growing. The list of options listed below is not a complete list. Please contact Liconic if you need functions not listed in this manual.



#### NOTE !

➤ In most cases it is not possible to retrofit options in the field

## 3.2 StoreX Climate Options

### 3.2.1 StoreX IC

(Incubator System)

### 3.2.2 StoreX HC

(Humid Cooling System)

### 3.2.3 StoreX DC

(Dry Cooling System)

### 3.2.4 StoreX HR

(Humid Wide Range Cooling and Heating System)

### 3.2.5 StoreX DR

(Dry Cooling and Heating System)

### 3.2.6 StoreX DF

(Deep Freezer System)

## 3.3 StoreX Configurations

### 3.3.1 StandAlone (SA)

StandAlone configured units are intended for ground floor operation. These units have the Gate located in the upper part of the unit. The transfer position is at approximately at the height of a typical table (1000mm). A StandAlone unit can therefore be placed next to a table or a robotic instrument.

The instrument's controls and climate generator are located below the incubation chamber. StoreX SA (StandAlone) may easily be lifted and moved by a forklift. The top cover may be used as a table and can hold other instruments.

The picture below shows a StoreX STX200 in StandAlone configuration. Note that all StoreX models are available in StandAlone configuration. Larger capacity

models are available as StandAlones only. A StandAlone StoreX may carry a BenchTop configured StoreX.

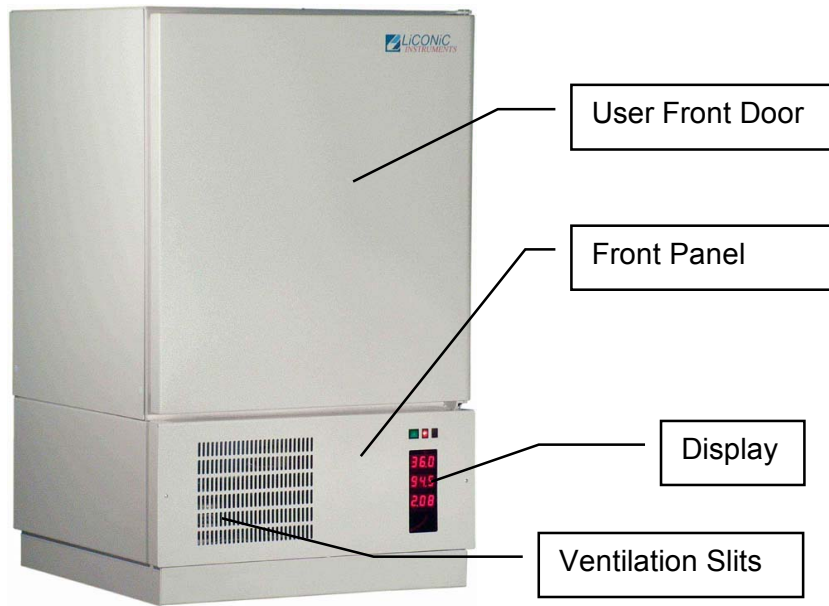

### 3.3.2 BenchTop (BT)

BenchTop (BT) configured units are intended for operation on a table or on top of a StandAlone configured StoreX. These units have the Gate located in the lower part of the unit. The transfer position is kept as close to the table surface (as low) as possible (200mm). This configuration is used when the StoreX is integrated on an existing table.

The instrument's controls and climate generator are located above the incubation chamber. The picture below shows a StoreX STX40 in BenchTop configuration. Note that only low capacity (up to ~200 plates) StoreX models are available in BenchTop. Larger capacity models are available as StandAlones only.

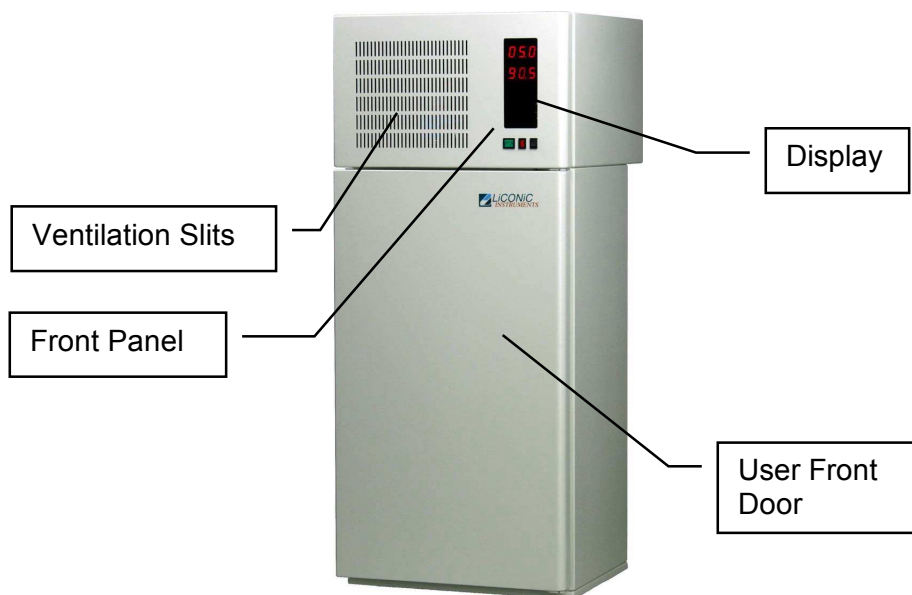



### 3.3.3 Copper Climate Chamber

All StoreX are available with a full copper incubation chamber. This feature ensures a maximum protection against cross-contamination inside the incubation chamber.



### 3.4 RH-Option

The RH Option allows the display and control of humidity inside the incubation chamber. A very high quality sensor is used in this option. Quality and accuracy of the sensor is maintained by the Swiss Federal Office of Metrology and the Swiss Accreditation Service.

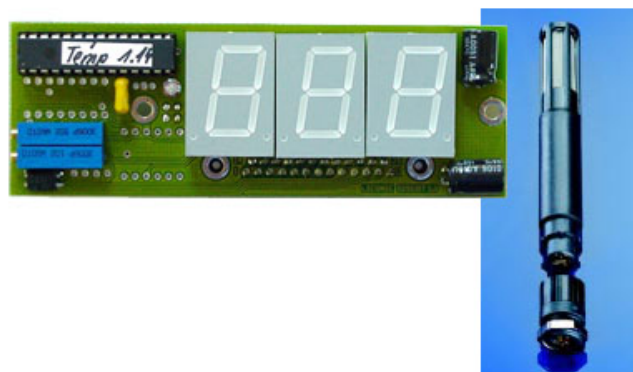

#### ***Principle of Operation***

The Humidity sensors used in the StoreX series are suitable for extremely high humidity as well as for extreme dryness. They incorporate a humidity and a temperature sensor allowing a relative humidity (RH) readout.

## Specifications

Measuring Range	0..100	% RH
Accuracy@23°C	±1.5 ±1.3	% RH °K Temp.
Resolution	12 12	Bit / 0.02% Bit / 0.1°C
Sensor	PT100 C94	Temperature Humidity
Adjustment	-	E2-PROM

## 3.5 Gassing Options

### 3.5.1 Gassing Conditioner

The Gassing conditioner is required for Gassing Options. Note that the Gassing Conditioner is required one time regardless of the number of Gassing Options used in a system.

### 3.5.2 CO2 Carbon Dioxide Option

As StoreX incubators have to cope with frequent accesses they use a very advanced CO2 controller that is extremely accurate, fast and stable.

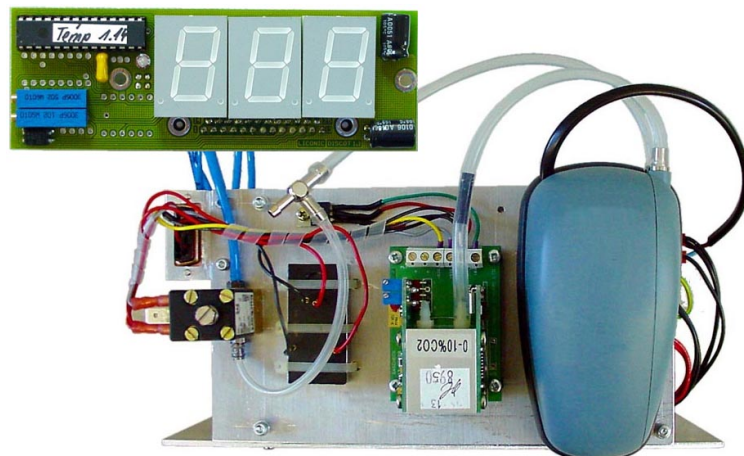

The CO2 Option of StoreX incubators consists of

- Gassing conditioner
- Gassing Controller
- Measurement Cell

## Principle of Operation

The infra-red spectra of many gases are characterized by narrow, non-overlapping absorption bands. Thus, the measurement of absorption within a defined wavelength band can uniquely identify the presence and concentration of a particular gas.

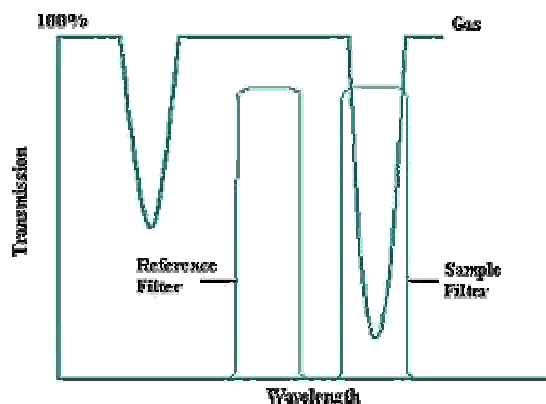

In NDIR gas sensors, an infrared optical 'sample' filter with a narrow band of transmission is selected to overlap with the absorption band of interest, the position of the filter determines which gas will be measured and the amount of absorption determines the gas concentration present.

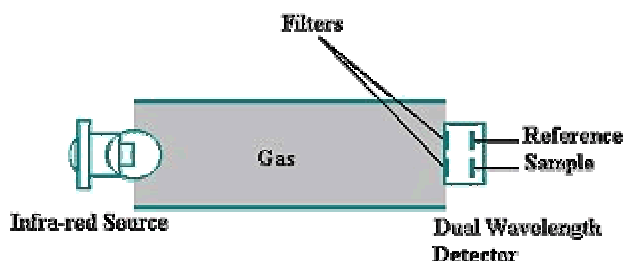

The infrared filter is chosen to ensure that the sensor is totally gas specific and will not exhibit cross sensitivity to other gases.

## Specifications

Measuring Range	0..10	% Vol.
Input Pressure*	0.8-1 4	bar typ. bar max.
Gas Flow	~10	l/min max.
Gas Consumption @ 5% CO <sub>2</sub> , 37°C S	<1 ~7 ~18	l/h standby l/h 2-min.-access cycles l/h 30sec.-access cycles
Measuring Wavelength	4200	nm
Accuracy	±3	% FS
Stability	±5	% over 12 month
Repeatability	±0.5	% at zero % at full scale
Response Time	~30	s
Warm-Up Time	5 30	min. operation min full accuracy
MTBF	5	years

\* Pressure <1bar are possible but may require additional adjustment for best accuracy

### 3.5.3 N2 Nitrogen Option

As StoreX incubators have to cope with frequent accesses they use a high quality N2 controller. The nitrogen measurement is based on an oxygen measurement. The N2 option therefore assumes that oxygen is displaced by nitrogen.

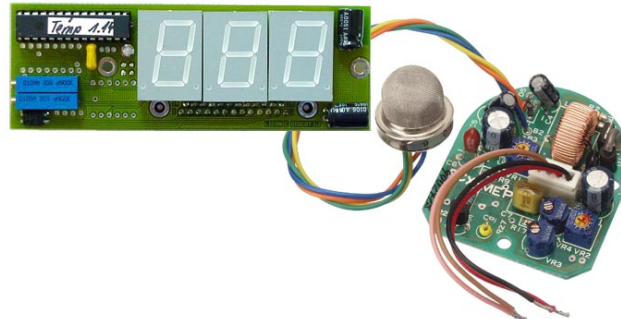

The N2 Option of StoreX incubators consists of

- Gassing conditioner
- Gassing Controller
- Measurement Cell

#### **Principle of Operation**

A zirconia electrolyte disc with electrodes on both sides has the ability to pass oxygen ions at high temperature.

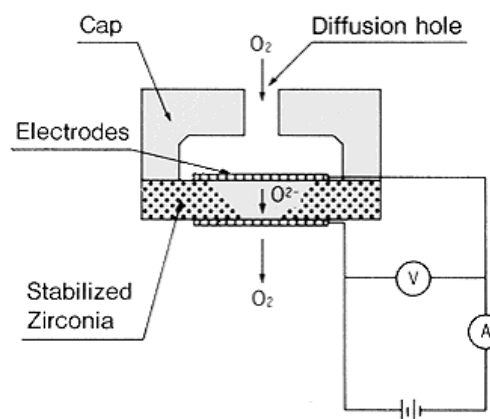

By attaching a cap with an aperture on one side (cathode) of the disc, the gas diffusion is limited and the saturated current is observed. It is termed "limiting current". The limiting current is proportional to the ambient oxygen concentration.

#### **Specifications**

Measuring Range	75..99.9	% Vol.
Input Pressure	1 4	bar typ. bar max.
Gas Flow	~10	l/min max.
Accuracy	±0.5	% FS
Stability	±0.5	% FS over 12 month
Repeatability	±1	% at full scale
Response Time	~30	s
Warm-Up Time	5	min. operation
MTBF	30'000	hrs

### 3.5.4 O2 Oxygen Option

The sensors for oxygen measurement are based on the same principles as described above. The main difference is the measurement range of the sensor used in the O2 option.

#### Specifications

Measuring Range	0.1..25	% Vol.
Input Pressure	1 4	bar typ. bar max.
Gas Flow	~10	l/min max.
Accuracy	±0.5	% FS
Stability	±0.5	% FS over 12 month
Repeatability	±1	% at full scale
Response Time	~30	s
Warm-Up Time	5	min. operation
MTBF	30'000	hrs



**WARNING !**

O2-Option leads to increased explosion risk

The maximum concentration of oxygen allowed with this option is limited to 25% O2 vol. for safety reasons.

### 3.5.5 Other Gassing Options

There are other gassing options available. Please contact Liconic applications for further information.

## 3.6 UHS (Ultra High Speed) Option

Applications with very short access times. The access speed of the UHS handler is almost double compared to standard High Speed handlers. Access time for UHS STX40 units is maximum ~12 seconds and for larger units access time is maximum ~20 seconds. Please ask for the latest specifications for your model.

## 3.7 Customized Color

Standard coating of the StoreX is RAL 9016. Other customized coating is possible. Please specify RAL code and/or send sample. Note that this option will increase delivery time.

## 4. Accessories

### 4.1 STX Stackers

The total stacker capacity depends on the unit size. A list of the number of stackers for each unit is given in the table below.

Instrument	Configuration	Number of Stackers
STX40	SA, BT, IT	2
STX100	SA, BT	5
STX200	SA, BT	9
STX500	SA	10
STX500-2	SA	20
STX1000	SA	20
STX1000-2	SA	40

A standard MTP stacker has 22 slots for Standard Microplates, the latter can be identified if a Barcode Reader Option is installed. The stackers can be modified to hold 11 half-heights or 7 Deep Well Plates. For better capacity use the proper stacker type. The table below lists some commonly used stacker types. These sizes are stock items other sizes are available.

Stacker	Levels		Pitch
	StX 40 / 100 / 200 STX 500-2 / 1000-2	StX 500 / 1000	StX 40
Nanotiterplates	42	--	11 mm
Microtiterplates	22	53	23 mm
Deep Well Plates	9	25	50 mm

The StoreX can handle almost every plate currently available on the market. For optimum performance LiCONiC offers a variety of stackers. Apart from the standard stacker sizes, customized sizes are available on request.

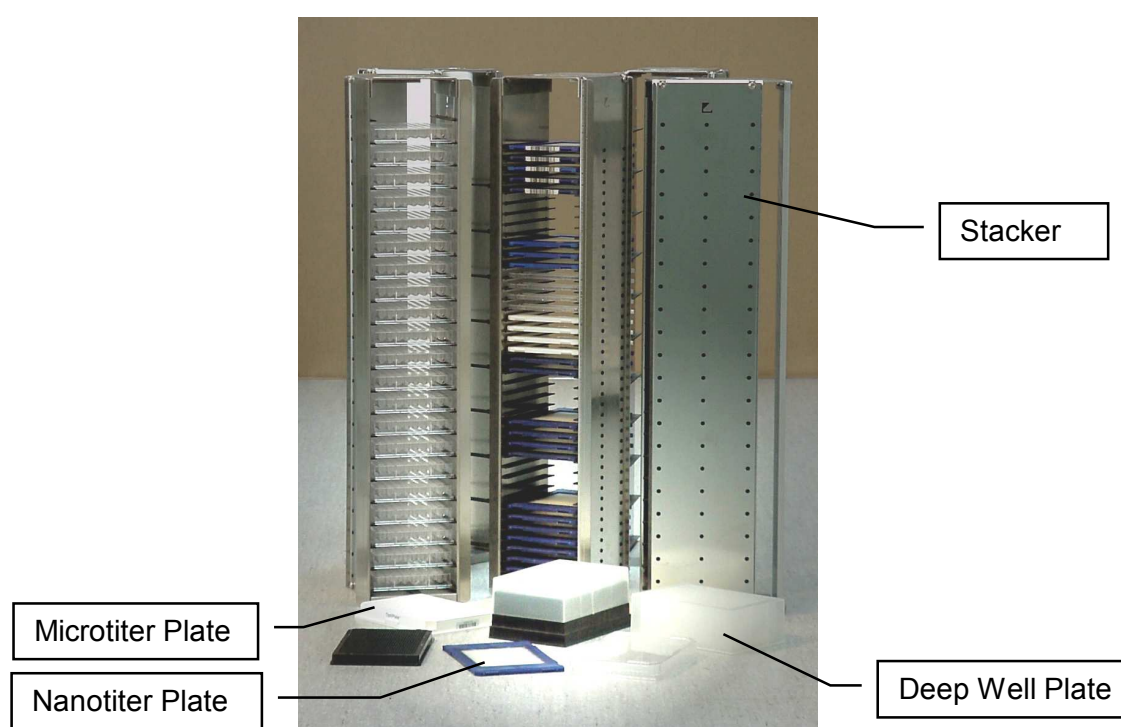

## 4.2 STX Transfer Stations

### 4.2.1 Standard Transfer Station

A variety of transfer stations are available. The transfer station is accessed by the StoreX handler as well as any external robot. StoreX transfer stations allow most grippers access to the plate. All StoreX transfer stations are equipped with alignment pins that realign the plates in both horizontal directions. The alignment works for StoreX handling as well as for any external robotic transportation system.

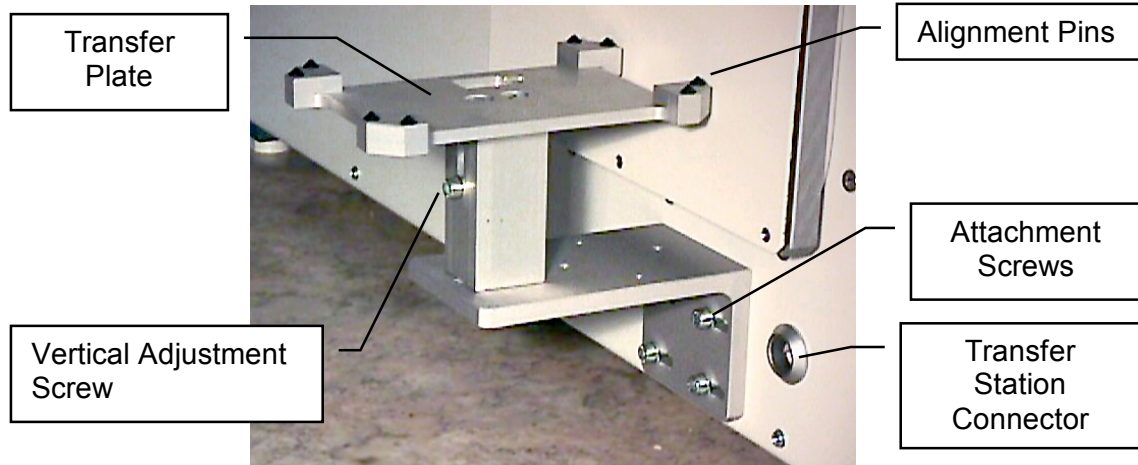

The transfer station can be easily adjusted. The transfer plate can be adjusted horizontally and vertically. Rotation of the transfer plate can also be adjusted.

The presence of a plate on the transfer station can be checked by via the plate sensor. The plate sensor status can be requested through the handling communication port.

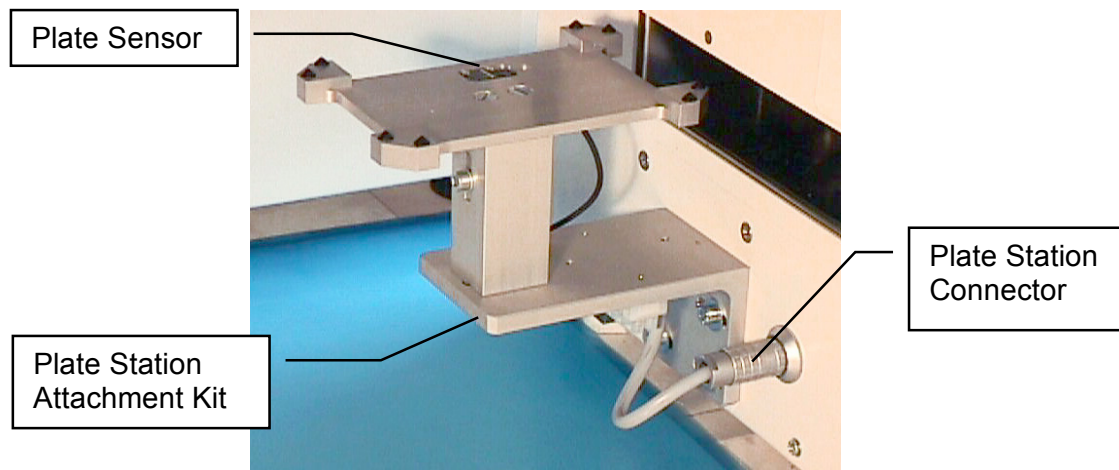

## 4.2.2 Turn Station

The StoreX handler transports plates along their longer axis. Many systems require the plate to be presented at a rotation of 90 degrees. The Turn Station will rotate each plate before and after the access by the StoreX handler.

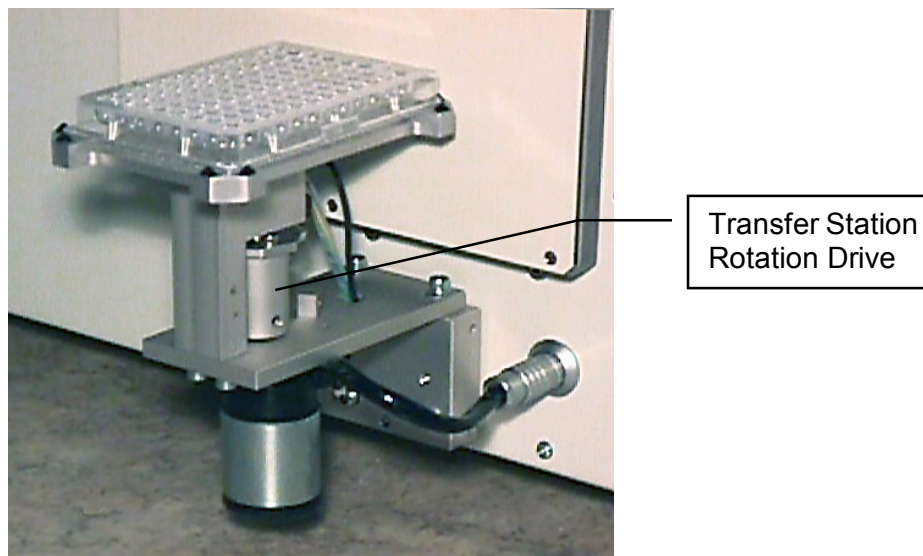

Rotation is controlled by the StoreX system. No additional external software is required.

## 4.2.3 Swap Station

The Swap station has two transfer plates mounted on a rotation (swap-) drive. The swap drive rotates the two transfer plates by 180 degrees. The swap station acts as a plate buffer as well as a plate extension shuttle. The distance of the actual transfer position is increased by 145 mm.

The swap station is controlled by the user system. The swap station is accessed through the handling communication port. The StoreX system monitors possible conflicts with the StoreX handler and the Swap Station.

The swap station has two integrated plate sensors. Both sensor statuses can be requested individually.

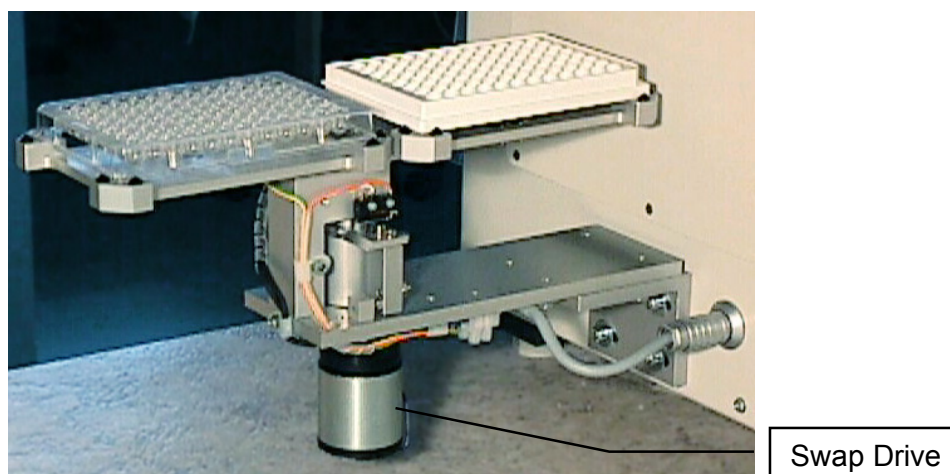



### 4.3 Slide Station

When the distance of the transfer location to the StoreX is not sufficient, it may be extended by the Slide Station. The Slide Station has a linearly displaceable Transfer Plate. The travel path of the Transfer Plate is approximately 170 mm.

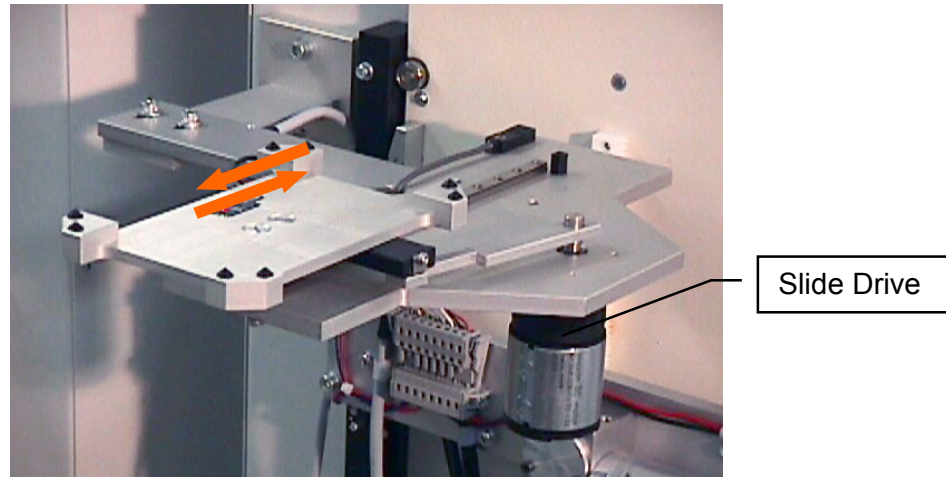

The movements of the Shuttle Station are controlled by the StoreX system. Each time a plate is accessed by the StoreX handling, the Transfer Plate is moved towards the StoreX unit. After access by StoreX the Plate Shuttle is extended towards the external system.

### 4.4 Lift Station

When Standalone machines are placed under the Table they can be provided with a Lift Station to transfer the Plates to a external system.

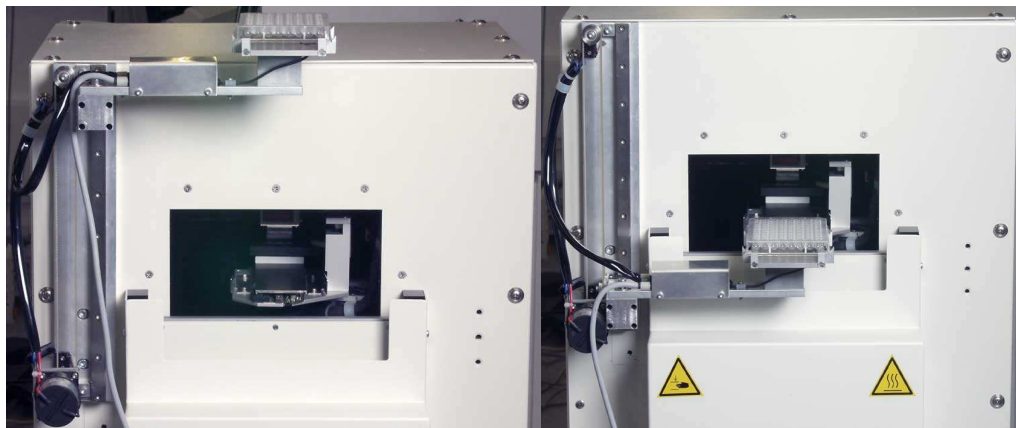

The Lift Station is normally in upper Position, when Handler loads or unloads a Plate to the Station the station goes to the load Position.

## 4.5 Shuttle Station

The function of the shuttle-station is for the elimination of “inter transfer module”, space constants, and complications of adding robotic arms for distances of 170-1000 mm. The source plates can be transferred from one work area to another with precision accuracy. This delivery system can be used for multiple functions and work-station designs.

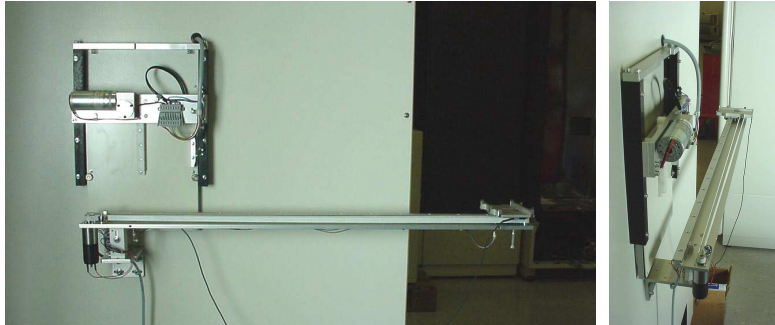

The belt driven system ensures smooth transfer and accuracy of delivery. The Slide Station is normally in far off Position, when Handler loads or unloads a Plate to the Station the station goes to the load Position.

### 4.5.1 Standard Transfer Plate

There are Transfer Plates available for applications where the transfer position is mechanically attached to the external system. Transfer Plates have alignment features. Transfer Plates are manufactured in aluminum with an anodized surface finish.

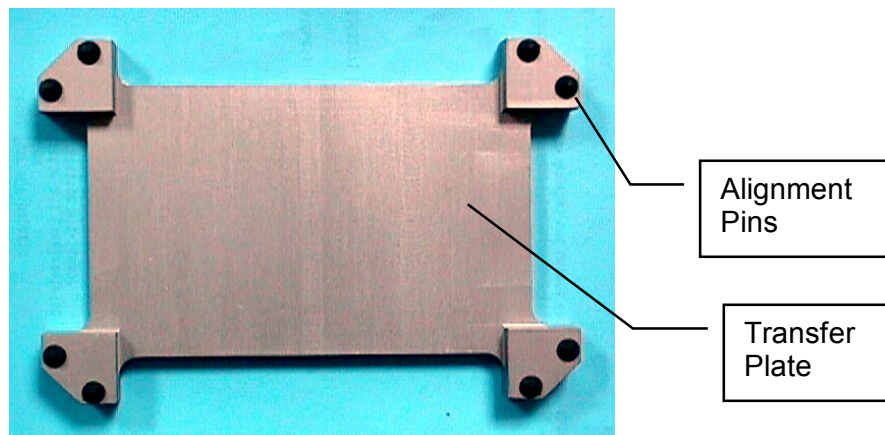

#### 4.5.2 NTP (Nano Titer Plate) Transfer Plate

Transfer Plate for NTP (Nano Titer Plates) and other very high density plates.

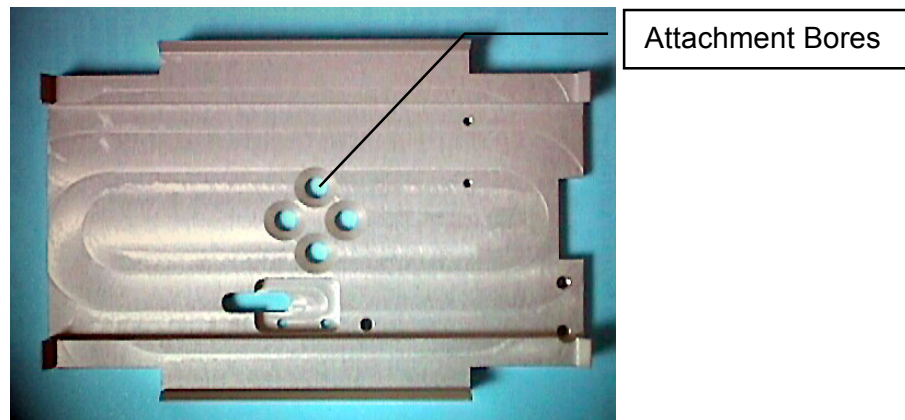

This Transfer Plate is best suited for high alignment accuracy and for very light plates. This Transfer Plate can be equipped with Active Alignment for even higher alignment needs.

#### 4.5.3 Transfer Plate Sensor

A sensitive optical sensor can be integrated into the StoreX Transfer Stations. The Transfer Plate Sensor will detect all commonly used plates. Transparent, opaque, white or black plates are detected. The miniaturized design of the sensor helps to keep the Transfer Station flat. The Transfer Plate Sensor is connected to the StoreX system. The sensor status can be requested through the handling communication port.

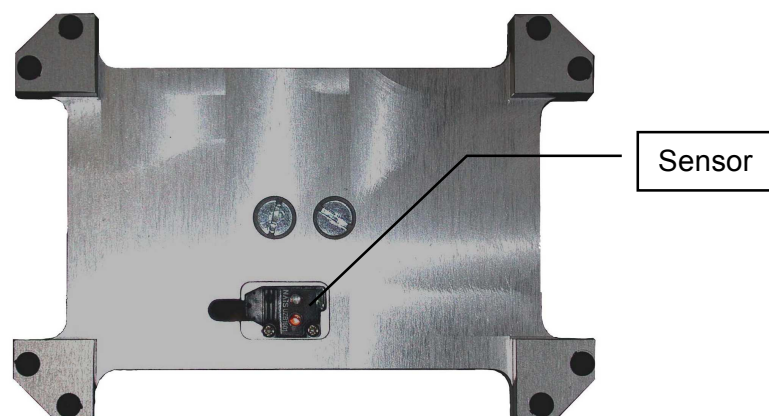

#### 4.5.4 Active Plate Alignment

For applications requiring extremely high alignment accuracy there is an Active Plate Alignment available. The Active Plate Alignment is attached to the Transfer Plate. Every time a plate is accessed by the external system, the Active Plate Alignment is selected. The alignment takes approximately one second. The alignment accuracy is accurate to more than 0.1 mm.

The Active Plate Alignment is controlled by the external system. The access is performed through the handler communication port.

## 4.6 Bar Code Reader

### 4.6.1 General Information

A Bar Code Reader can be installed on the Lift Assembly. It allows the reading of Bar Codes on plates stored in the stackers. Bar Codes have to be printed on the shorter side of the plates and have to face outwards to the StoreX Lift Assembly.



### 4.6.2 Supported Barcode Types

The optional Barcode reader recognizes the following barcode types.

- Code 128            number of characters: 1..32
- Code 39            number of characters: 3 .. 32
- Coda bar            number of characters: 3..32
- EAN(UPC (A/E)    EAN 13, EAN 8, UPC-E
- ITF
- Industrial 2 of 5
- COOP 2of5
- Code 93
- EAN-128

### 4.6.3 Barcode Specifications

- Light Source:            Semiconductor Laser
- Wavelength:            650nm
- Output:                    1.5mW
- Class:                      FDA: Class II  
IEC 825-1 11.1993: Class 2  
DIN EN 608251 07.1994: Klasse 2
- Reading Bar Width:    0.125 – 1.0 mm  
0.15 – 1.0 mm for Code 93 and Code 128
- Ambient Light:           Sunlight 10'000 lx
- Incandescent Lamp:    6'000 lx

## 4.7 Scheduler

An independent Scheduler traces the location and specified duration of an item in the climate chamber, notifying you when the scheduled time is completed. The Scheduler is timed by the StoreX internal clock. Two operation modes can be selected:

The Trace Mode monitors the length of time each plate has been in the climate chamber, notifying you at the time of the unloading of the plate. The actual time can be read by the external system through the handler communication port.

The Alarm Mode notifies the external system when plates have fulfilled their specified time period in the climate chamber. The specific time period of each plate can be set at the time of loading the plate.

## 5. Packing and Transport

For transportation of the StoreX unit remove stackers from the climate chamber and secure the lift assembly in its turned-in position. Always use the original StoreX box for transportation. Do not lift the unit at the front door or at the Gate-Assembly. Use a fork-lift when moving the instrument.



### CAUTION !

- The StoreX unit weights up to 100kg (200 lbs.). Use adequate equipment for transportation and/or movement of the instrument.
- Transport unit in upright position with stackers removed from the climate chamber.
- Do not use front door or Gate as handles.

When installing the instrument follow the described steps in the order given below.

### 5.1 Unpacking the Instrument

- Unpacking the instrument is best done by two people
- Remove fastening straps and open the wooden box on the upper side



- Remove Stackers and Foam Top
- Open one Side of the wooden box, then the other
- Lift the StoreX from the pallet base and carefully place it on the floor
- Open the front door and remove the protective-wrapping from the lift assembly
- Remove the tape and wrapping that secures the Handler to its home position
- Remove Stackers and Foam Top
- Lift the cardboard box from over the instrument

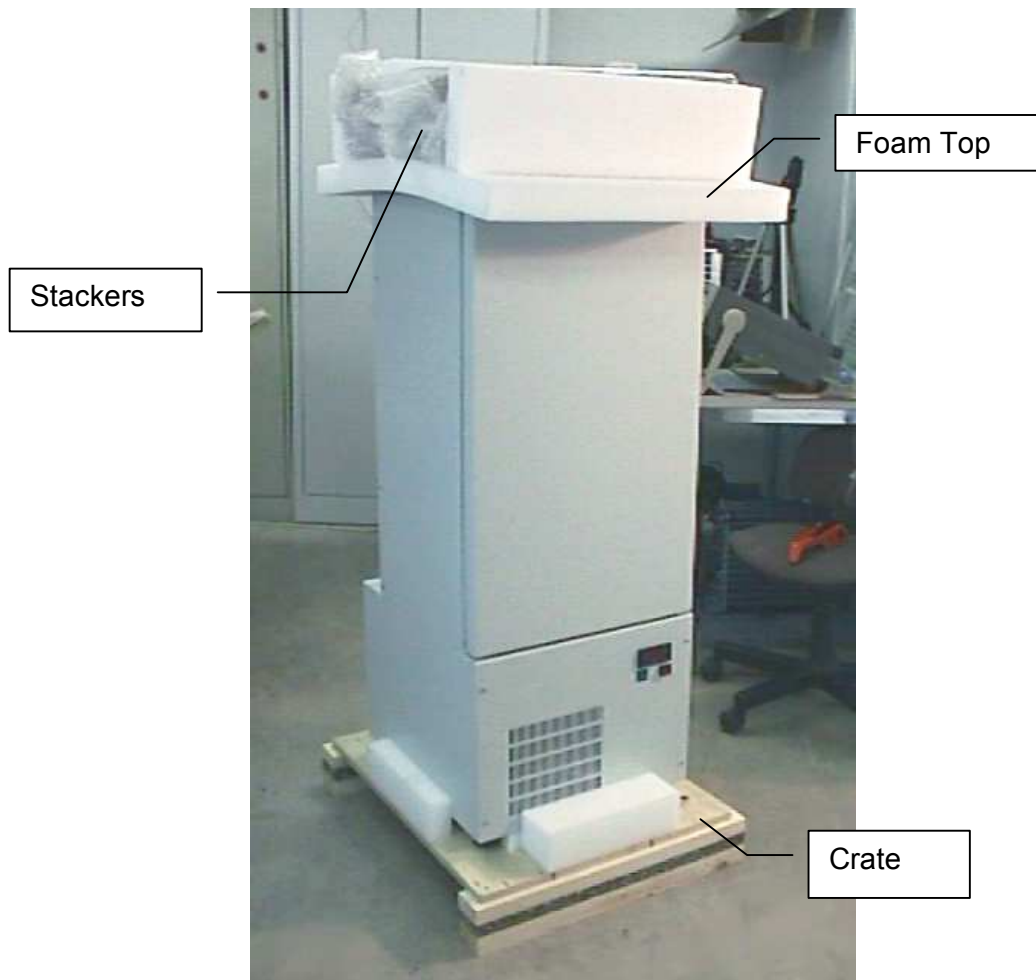

- Lift the StoreX from the pallet base and carefully place it to the floor
- Open the front door and remove the protective-wrapping from the lift assembly
- Open the front door and remove the protective-wrapping from the lift assembly

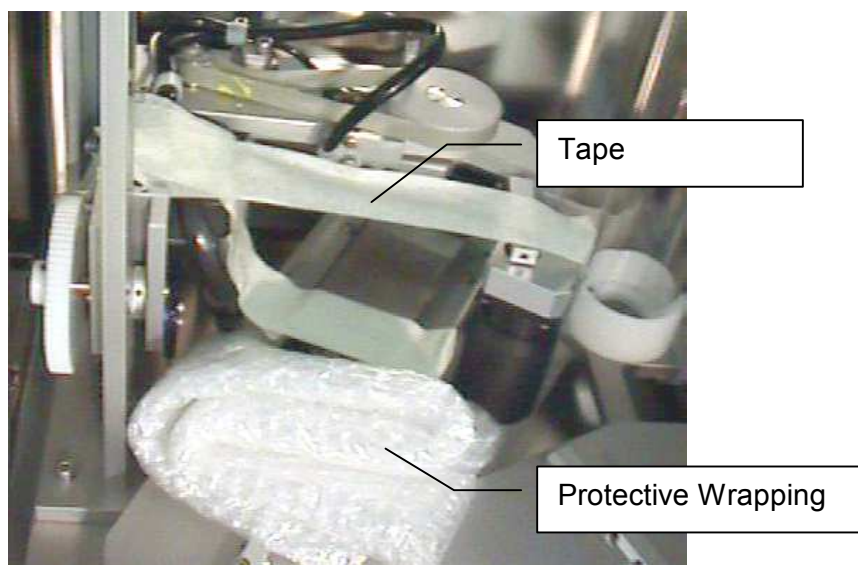

## 6. Installation of the Instrument

Only a trained System Integrator should install the LiCONiC StoreX. Operate the instrument in a dry and clean environment only. Note that external climate situations may influence the performance of the instrument.



### CAUTION !

After installation of the StoreX with a System, do not move either of them. Correct functioning of microplate transfer between the System and the StoreX relies very much on the position of the StoreX in relation to the System.

The instrument must stand firmly on a horizontal surface. Make sure that there is no mechanical interference between the gate and any other equipment.

Adjust the four feet to the desired height and until the instrument is horizontal. Use a metric spanner size 12 for adjustment and size 17 to secure. Turning the Adjustment Screw Clockwise will increase the height of the instrument.

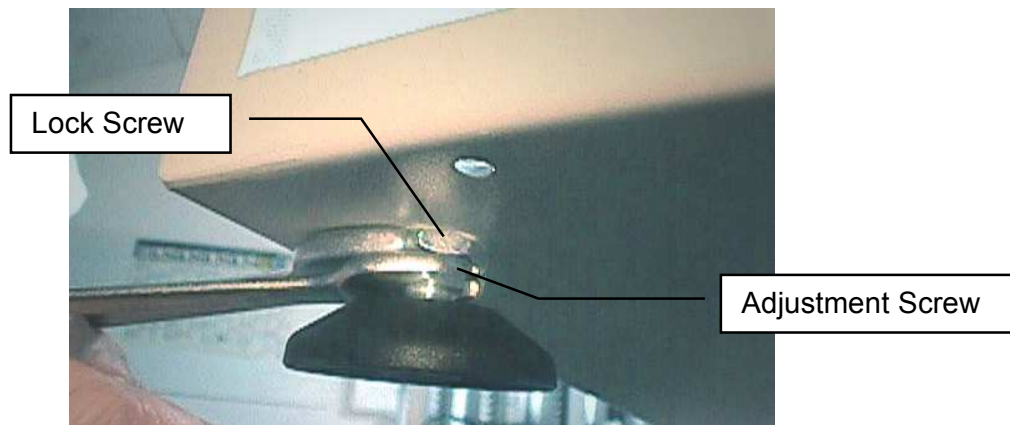

Check that each foot has contact with the ground and that the instrument's weight is evenly distributed over all four feet. Allow enough room between the underside and the ground floor. Check rear of instrument for free Gate movement.

For optimum space usage you may put several StoreX units alongside each other. Allow approximately 10 to 20 mm clearance between units. The minimum clearance from the ground is 30 mm. StoreX Cooling units have their air inlets on the underside. Therefore the StoreX unit should only be operated in a clean environment. Consult the maintenance guide for cleaning instructions.

The air outlet is located on the front panel. The front panel must not be blocked by any obstacle. Allow for free air circulation.



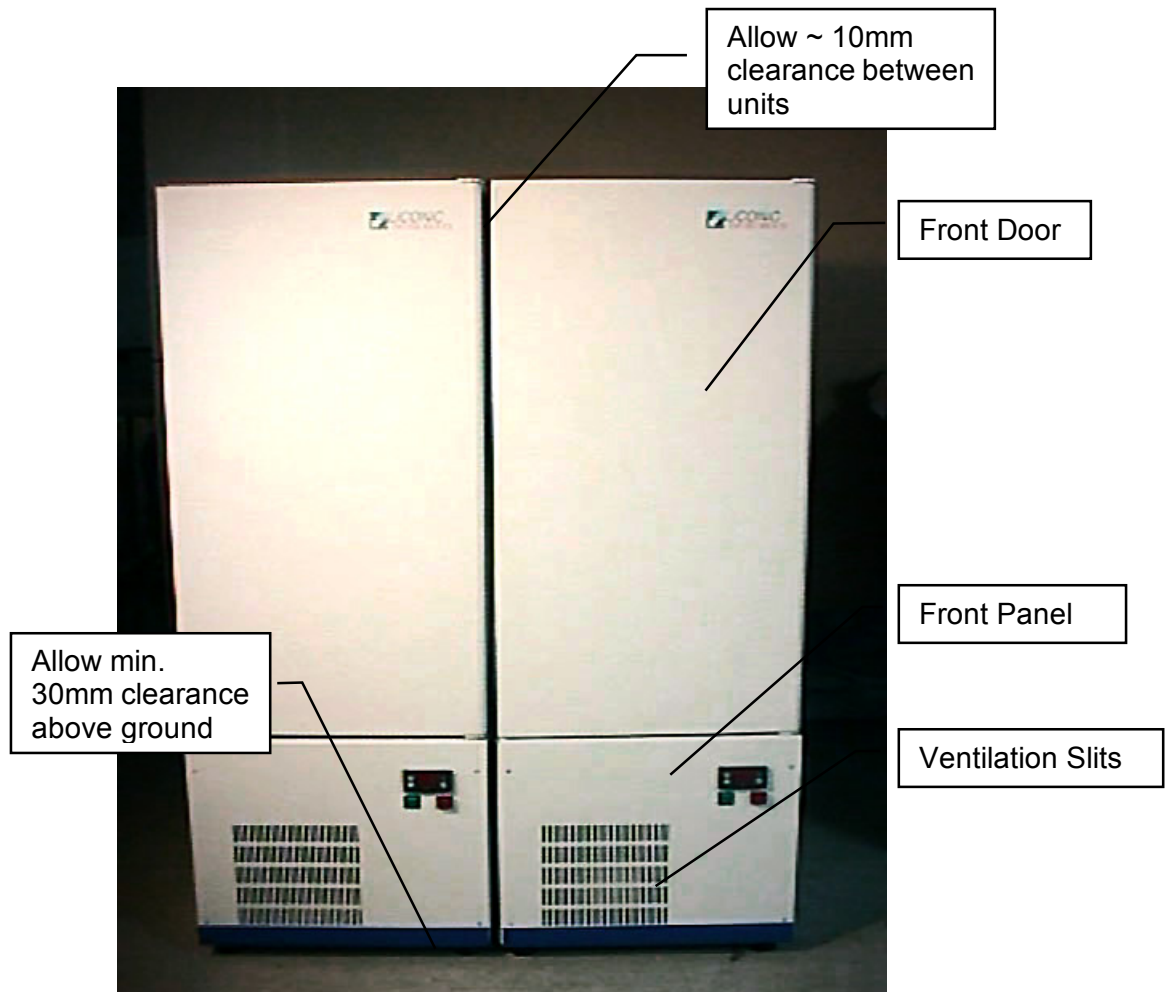

Instruments with cooling options should not be operated immediately after transportation. Leave instrument turned off for at least 12 hours.

The picture below shows another possibility for arranging StoreX units. This example depicts the combination of two StandAlone units and one BenchTop unit. This arrangement allows maximum usage of valuable laboratory space. For easy integration and short access paths the Gate of BenchTop units is located near the bottom of the unit while the Gate of Stand Alone units is located near the top of the instrument.

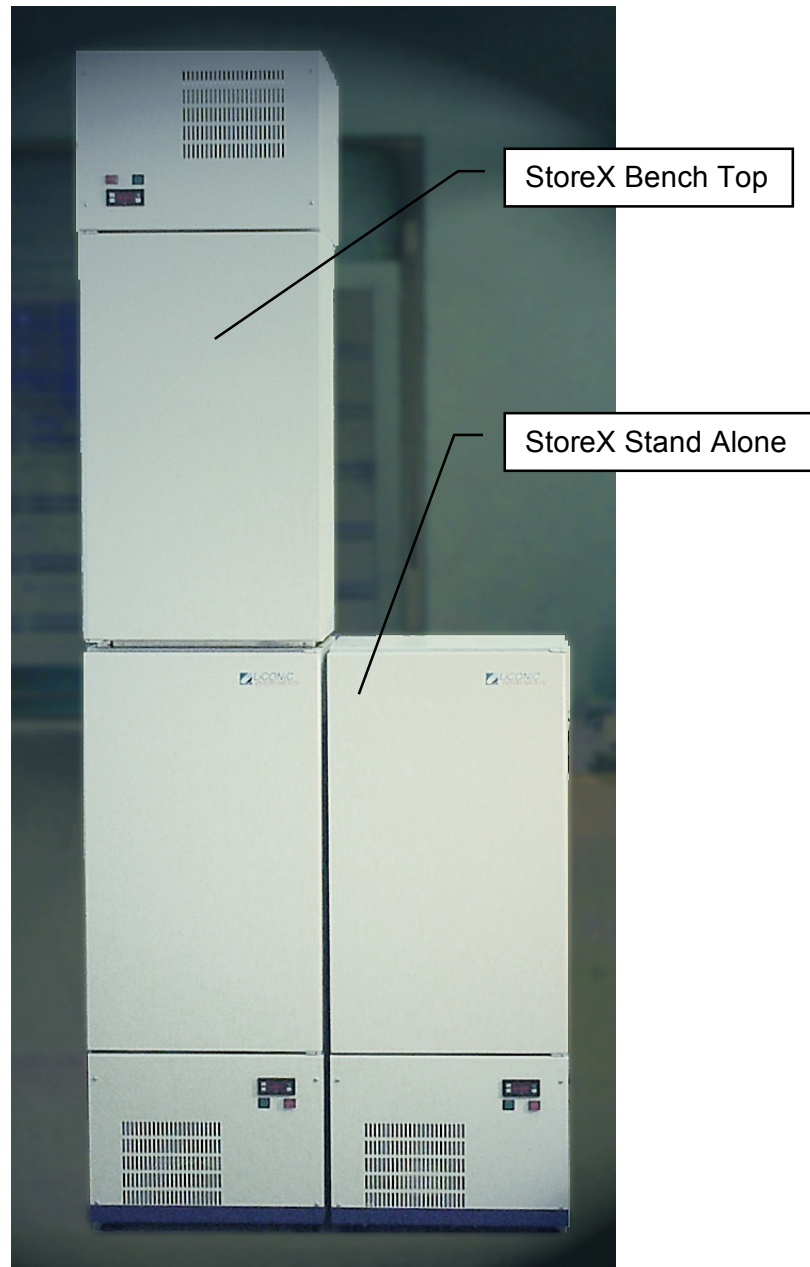

A rear view of the instrument with some important measurements is given in the chapter “Transfer Station Adjustment“.



**CAUTION !**

- Never block the ventilation slits of an instrument
- Allow a minimum clearance of 30mm between the instrument and ground
- Instruments with cooling options must settle power-off for at least 12 hours
- Operate instrument in clean and dry environments only
- Consult the chapter on Cleaning Instructions

## 6.1 Transfer Station Position

This procedure explains how to adjust the Transfer Station to the handling. The adjustment is done mechanically. For adjustment of the transfer position use the utility software delivered with the StoreX unit. Note that the adjustment of the transfer position requires some basic mechanical skills. Improper action may damage the instrument. If needed call LiCONiC Customer Service for assistance.

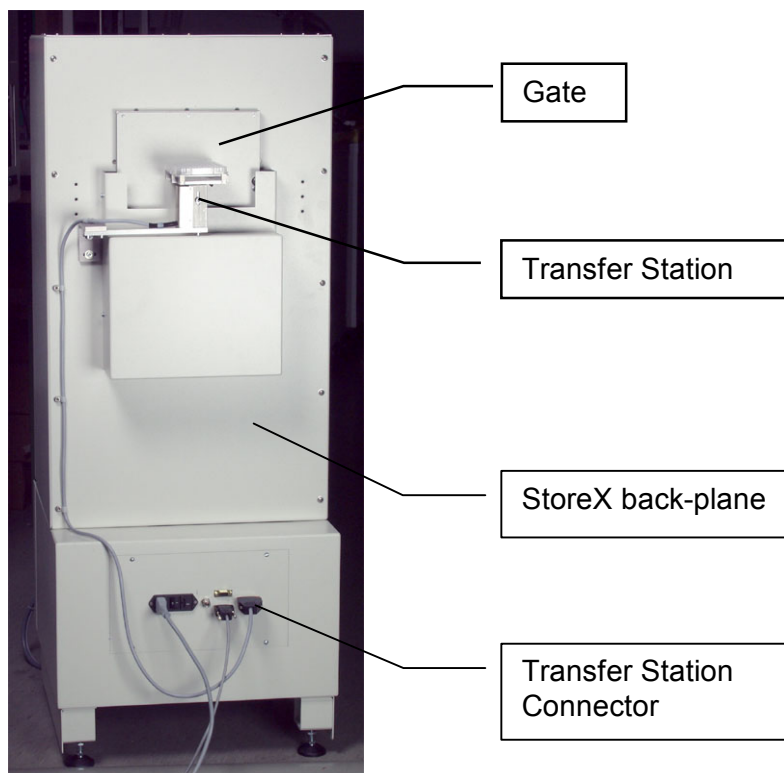

### CAUTION !

- Read this entire procedure *before* starting adjustment work
- There is a potential risk of injury from the Gate. Make sure that the Gate cannot be accessed by the operator during the procedure
- When setting up the instrument, be sure to leave enough room on the rear side for gate movement

Basically the Transfer Station consists of

- Transfer Plate
- Attachment Kit
- Transfer Station Sensor

The picture below shows the elements required for the attachment of the Transfer Station. The Transfer Station is attached to the back-plane of the StoreX by a pair of screws- screw (1) and screw (2). The two screws (1), (2) do not only hold the Transfer Station but also allow horizontal x-adjustment of the Transfer Plate parallel to the back-plane. Since the Transfer Station is dismantled for transport these two screws (1), (2) are the only ones that need to be adjusted. Note, the correct position of the Transfer Station is marked on the back-plane.

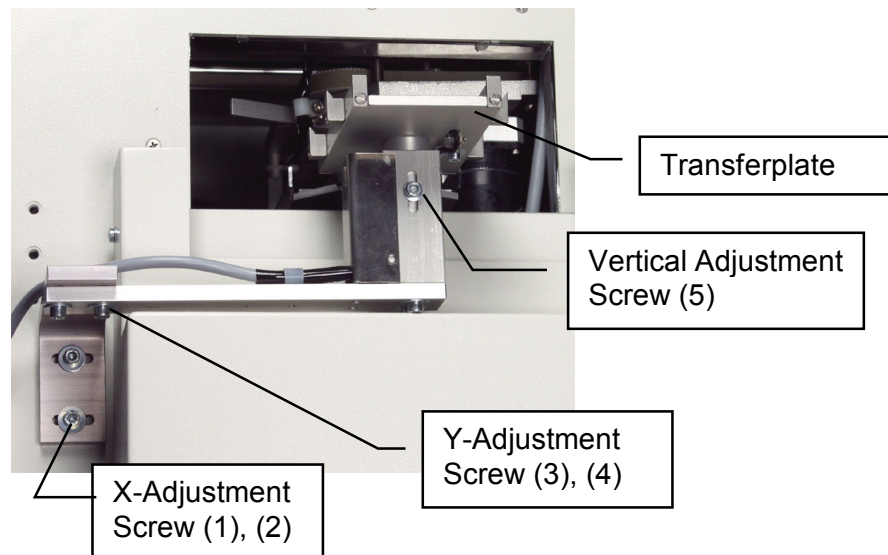

In order to adjust the Transfer Station in the Y-direction (perpendicular to the back-plane) use the screws (3) and (4) and slide the Transfer Station into position then tighten screws again. The Height of the Transfer Plate is adjusted by opening screw (5) and lifting or lowering the Transfer Plate. Again, tighten screw (5) after finishing the height adjustment.



<b>WARNING !</b>
➤ The Gate will move when running the STXFER utility program
➤ Do not put hands into the Gate opening.

There is a PC-run utility program to ease the adjustment of the Transfer Station. Start the program „STXFER.EXE“ on the STX Utility Diskette. After Startup the program will ask you the enter the comport to the StoreX.

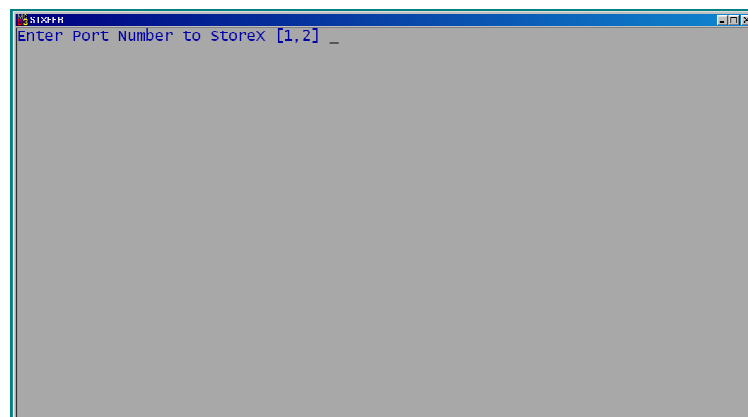

If you do not know the port number to the StoreX we recommend you run this program on a separate PC or laptop.

A warning will appear. Read the warning carefully. If you understood the warning and understand this set-up procedure type 'Y' to continue. If you have questions contact Liconic or your integrator.

```

StoreX
Enter Port Number to StoreX [1,2] 1
Open Comport 1
Communication Request to Hardware CC

Levels 21
CarPos 9
S-Nbr 12287
zOfs 50
dzPlc 400
zPth 1925
zXfer 600
dzXfer 1000
1650
Activate _
  
```

The program will now read the system constants. The constants are displayed during this operation. In case your StoreX has not been initialized, the program sends an initialization command.- Note that the initialization may take a few seconds.

After initialization is finished a command screen appears. In the upper half of this screen some important system constants are displayed. The middle area of the screen lists the commands.

```

LiCONiC Instruments                               StoreX X-fer station
-----
Serial Number          0           Carrousel Positions      9
Operator              Default      Cassette Levels         21
Date                  25-06-02    Lift z-Offset           0
Time                  22:11:50    Lift Cassette dz        0
Version               v 0.02,10.06.A0  Cassette Pitch           0
                                           x-fer station dz        0
-----
f .. Lower x-Fer.Position          F . Higher x-Fer.Position
s ..... Shovel In/Out             S ..... Shovel Test
^ ..... Lift Up                   v ..... Lift Down
< ..... Turn 1 Step In           > ..... Turn 1 Step Out
esc ..... Quit

Actual Lift Position                Actual Trun Position
Ready Bit
Please select now >
  
```

The table below explains the commands that are executed on pressing a key.

<b>f</b>	Lower Transferposition	Moves the lift to the lower level at the transfer station. This position is used when the shovel is fowarded or retracted under a plate on the Transfer Plate
<b>F</b>	Upper Transferposition	Moves the lift to the upper level at the Transfer Station. This position is used when the shovel is fowarded or retracted with a plate loaded on the shovel
<b>s</b>	Shovel In/Out	Moves the shovel out when it is in or moves the shovel in when it is out (toggle)
<b>S</b>	Shovel Test	Continously moves the shovel in and out
<b>↑</b>	Lift Up	Moves the lift Up by ~1mm
<b>↓</b>	Lift Down	Moves the lift Down by ~1mm
<b>←</b>	Lift Rotate Out	Rotates the lift turn mechanism Out
<b>→</b>	Lift Rotate In	Rotates the lift turn mechanism In

At this time that Gate should be opened and the StoreX handler should be turned out. The shovel is retracted. The pictures below give two views of this situation.

Check visually whether the Transfer Station is adjusted so that the shovel will be able to travel freely into the Transfer Plate. Check both, angular and height position of the shovel towards the Transfer Plate. If the Transfer Station does not seem to be aligned properly redo above adjustment steps using screws (1)-(5).

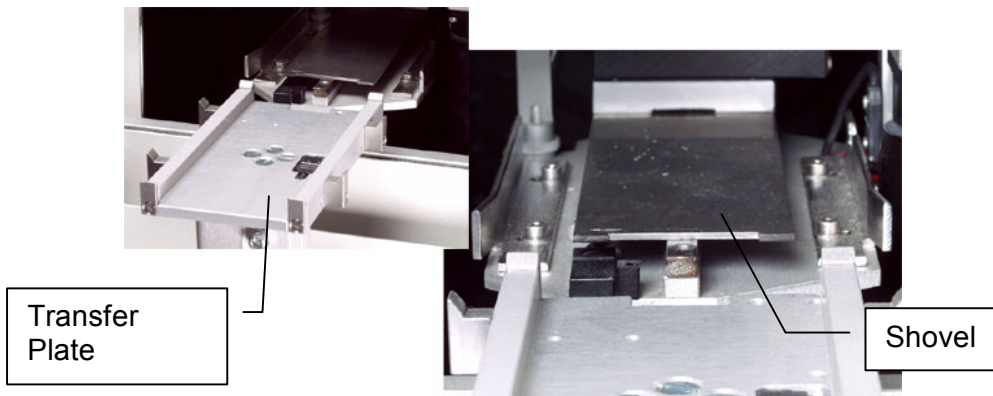

Once it looks safe to extract the shovel you may press 's' in the STXFER utility program. The shovel will travel to its outer position. This may look as shown in the pictures below.

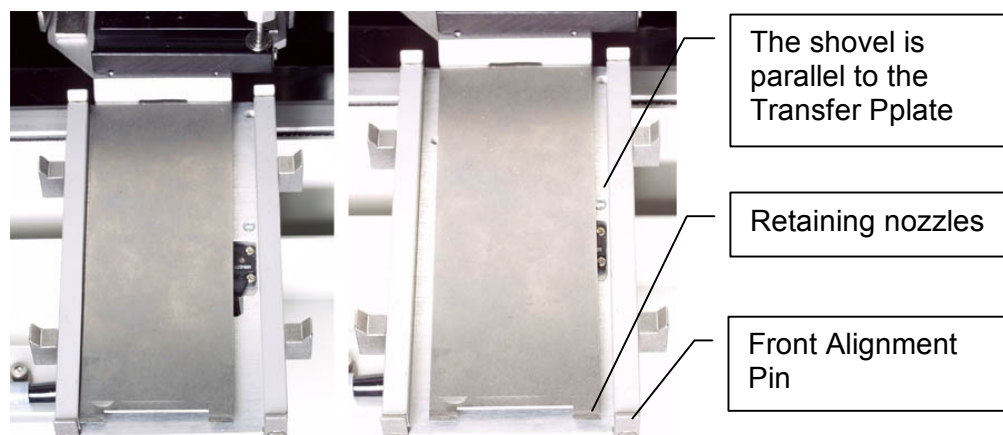

With the shovel extracted you may now adjust the Transfer Station more accurately. The Transfer Plate should be parallel to the Transfer Plate or station?. The two retaining nozzles at the front of the shovel should be parallel to the front edge of the Transfer Plate and behind the two front alignment pins.

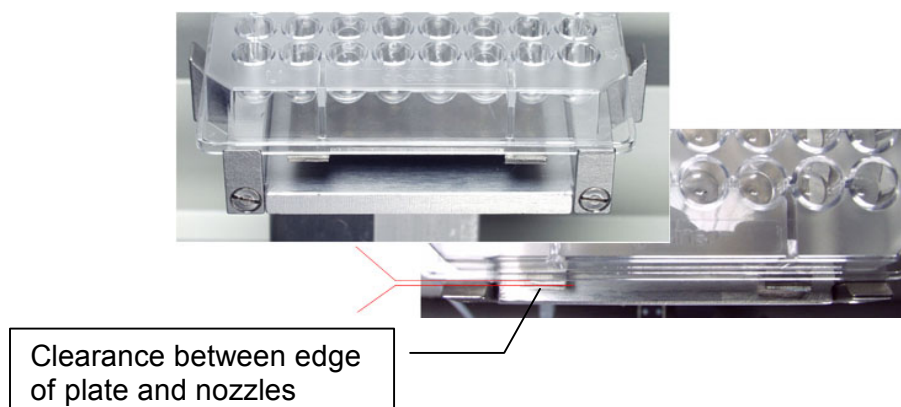

Check the shovel height. The lower surface of the shovel should be approximately 1-2 mm above the top surface of the Transfer Plate. The shovel should be high enough to allow movement without touching the Transfer Plate and low enough to pass under a plate placed on the Transfer Plate. Use screw (5) to optimize the Transfer Plate height. By selecting option 'S' (Capital-S) you can move the shovel back and forth continuously. This will allow you to observe the shovel adjustment more precisely.

After the mechanical adjustments there are software related constants that determine the location of the Transfer Station.

DM22	Data Memory 22	Defines the height of the lower level of the Transfer Station for the lift axis
DM26	Data Memory 26	Defines the travel path for lifting or lowering a plate at the Transfer Station
DM82	Data Memory 82	Defines the radial position at the Transfer Station for the run axis

These constants can only be changed by special software or by overwriting them on every cold start before initialization. Please refer to 'Remote Operation' for details.

The STXFER program will let you read the values for these constants. Under 'Actual Turn Position' in the main screen of the STXFER program you may read the position of the Turn motion, while under 'Actual Lift Position' the position of the lift motion is displayed. The value for DM22 is given at the lower transfer position. The value for DM26 is calculated by subtracting the lower transfer position from the upper transfer position.

## 6.2 Floor Loading Requirements

Minimum floor loading requirement for the biggest model StoreX BMX1000 is 224 psf = 1093 kg / m<sup>2</sup>

## 6.3 Electrical Connections

The electrical connections are at the rear of the instrument. Power and communication connectors are on the same panel. The Transfer Station connector feeds and controls the Transfer Station Option. The StoreX unit automatically detects the presence of a motorized Transfer Station through this connector. The Gas Connector connects to an optional gas supply such as CO<sub>2</sub>, Oxygen or Nitrogen. Beware of the maximum gas pressure of 6 bar.

### CAUTION !



- Switch the System off before connecting and disconnecting the LiCONiC StoreX
- Disconnect the RS-232 interface only with the power switched off
- Limit maximum length of communication cable to ~10 meters
- Use current converters or amplifiers for longer distances or when operating in a high field emissions environment

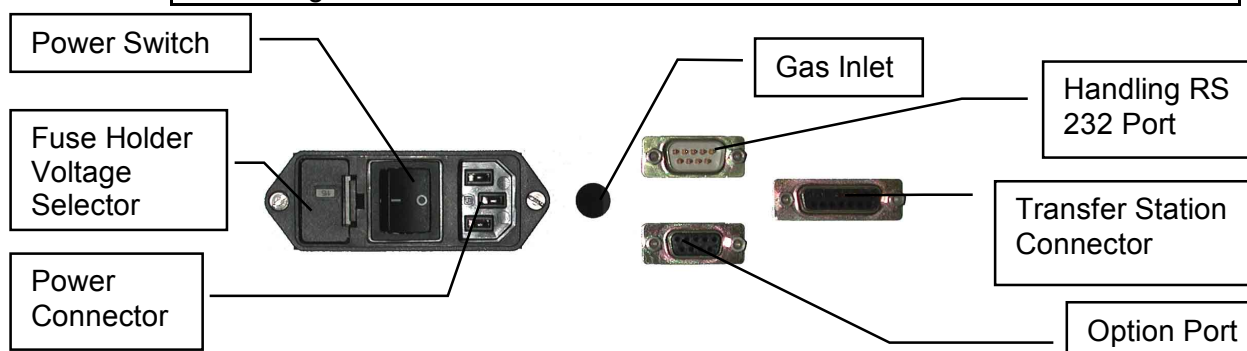

Prior to connecting the instrument to the power source choose the correct voltage setting and the appropriate fuse. The voltage selector is located at the rear of the instrument.

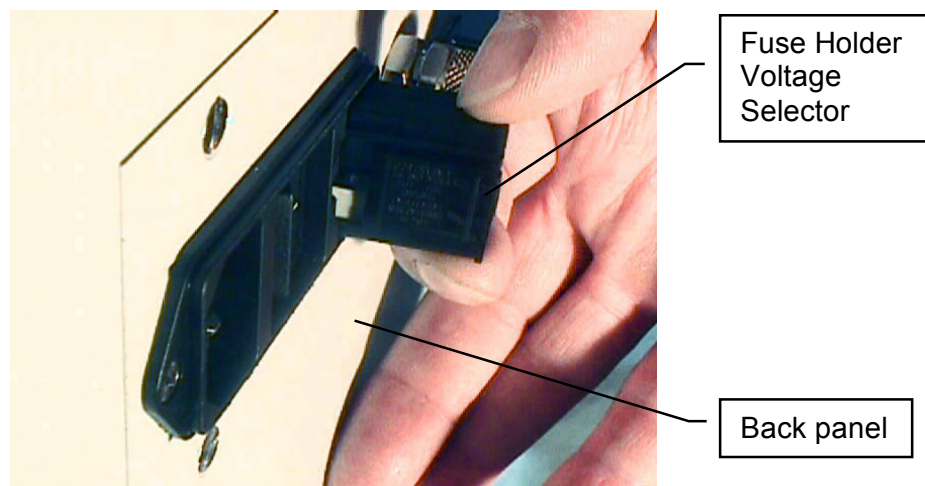

The voltage setting is displayed in a small window in the fuse holder.

### CAUTION !



- Beware of high voltage inside the instrument.
- Emergency stop functions have to be implemented by the integrator
- Do not open the covers with the mains still connected. Disconnect mains cable prior to any service and/or maintenance work.
- Incorrect voltage settings will permanently destroy the instrument.
- Instruments with an integrated cooling option must be operated at the specified mains frequency only.



- StoreX is a Class 1 (Protective Earthed) device. Mains connections must plug into power receptacles or power bar with reliable earth connection.
- One of the following three means can be considered as disconnecting device:
  - (1) detachable power cord plug;
  - (2) AC inlets or
  - (3) Mains switches.
 Equipment must be positioned so that the disconnecting device is easily accessible.

## 6.4 Communication Connections

For communication there is a serial communication port (9pin Sub-D male, crossed RX, TX) which is located at the rear of the incubator. The RTS and DSR, respectively DCD and DTR are connected internally (null modem).

The StoreX can be operated with a PC, Laptop or any other system with a RS-232 port option. Terminal programs are available for most systems. A demo software that includes a terminal option is shipped with each instrument. We recommend the use of this software to familiarize yourself with the command set of the StoreX system.

### External Serial Connector Cable AT-Link

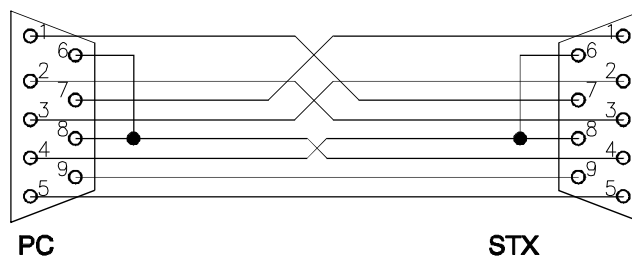

### External Serial Connector Cable Null-Modem

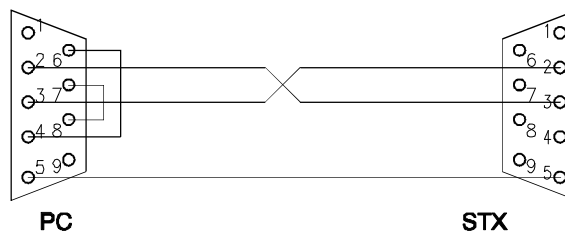

## External Serial Connector Cable Null-Modem

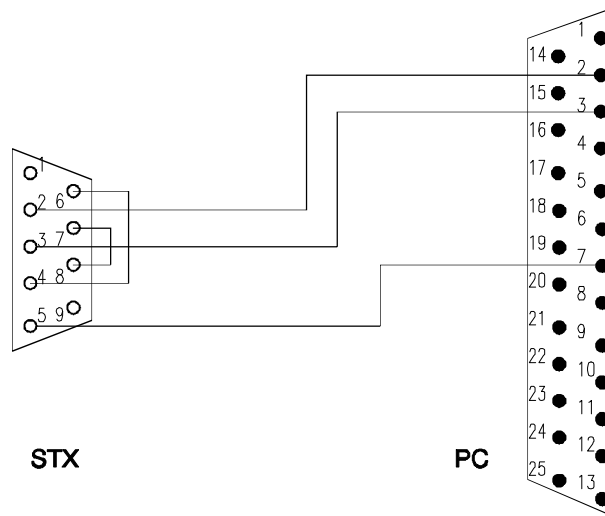

## Internal RS-232 Connector Cable

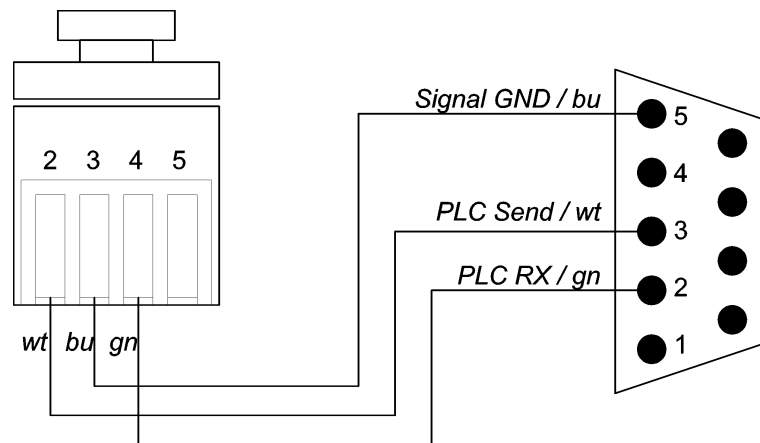

Handshake-lines are short-circuited internally.

## 6.5 Gassing Installation

### 6.5.1 StoreX Gassing Options

The StoreX series supports a wide selection of gassing options. Typical properties of some commonly used options are described next. There are other gassing options available. Note that each gassing option is linked to specific risks and hazards. It is important to be fully informed about any specific application before installing the instrument or even running any application.

### 6.5.2 Safety Information

#### **General**

Commonly used in research medicine are inert gases like: Nitrogen, Argon, Helium and Carbon Dioxide. Inert gases are used mainly to create and maintain inert atmospheres for an application or process. The above gases, which generally don't react with other materials, displace oxygen in order to maintain an inert, contaminant free atmosphere.

In their liquid form these gases are very cold, (the boiling point of liquid nitrogen is  $-196^{\circ}\text{C}$ ). Such cold liquids are known as cryogenic liquids, (from the Greek, kryos meaning frost and gene meaning producing).

#### **Major hazards**

There are some major hazards associated with these gases



WARNING !
➤ Inert gases are asphyxiates and will displace oxygen to produce localized oxygen deficient atmospheres
➤ Inert gases are odorless, colorless and tasteless
➤ Inert gases give no warning and may cause death in few seconds

Oxygen is the only gas, which supports life. The normal concentration in the air that we breathe is approximately 21%. If the oxygen concentration in air diminishes or, (what amounts to the same) if the concentration of inert gases increases, a situation is rapidly reached where the hazards of asphyxia become very great.

The danger occurs as soon as the oxygen levels are lower than 16%. Inert gases are odorless, colorless and tasteless and are therefore a great deal more dangerous than other gases such as chlorine, ammonia, or hydrogen sulfide, which can be detected by their odor, at very low concentrations. The asphyxiating effect of inert gases occurs without any preceding physiological signals which could alert the victim. It takes place very rapidly: just a few dozen seconds with very low oxygen content. Stated clearly "you do not notice that you are passing out!"

The danger from the inert gases such as nitrogen, argon, helium, etc cannot be stressed enough!! . Especially in this case of Asphyxia as there are no warning signs. People also vary considerably in their reactions to oxygen deficiency.



<p><b>WARNING !</b></p> <ul style="list-style-type: none"> <li>➤ In their liquid state inert gases are extremely cold fluids which can cause serious burns when in contact with the skin</li> <li>➤ A cryogenic spill often gives a low lying cloud of vapor that creeps along the ground</li> </ul>
--

When a cryogenic liquid is released into the atmosphere, it evaporates and forms a dense cloud. As it is very cold it is heavy and hangs close to the ground. So it will flow into any low lying areas, such as drains or pits. Therefore the first warning of a cryogenic spill is often given by the presence of a low lying cloud of vapor that creeps along the ground. These clouds can be dangerous, as their temperature or composition will be unknown. Visibility within the cloud is very low with the possibility of falling, perhaps into contact with the cryogenic liquid. If the cloud is nitrogen or argon then it is very likely that the cloud does not contain sufficient oxygen to support life. In this case unconsciousness could be immediate and death could follow.



<p><b>CAUTION !</b></p> <ul style="list-style-type: none"> <li>➤ When you see a cryogenic spill or a large vapor cloud notify qualified personnel immediately</li> <li>➤ Shut off the source of liquid, by a <i>REMOTELY</i> controlled valve</li> <li>➤ Do not enter a vapor cloud caused by vaporizing cryogenic liquid</li> <li>➤ <b>DO NOT SMOKE!</b></li> </ul>
--

When you see a cryogenic spill or a large vapor cloud notify qualified personnel immediately. Call the Fire Department in the case of a large liquid oxygen spill. Have them stand by until the spillage is dispersed.

If possible shut off the source of liquid, by a *remotely* controlled valve if one is fitted. Do not expose yourself to the hazard, such as high oxygen, combustible or asphyxiating atmospheres or cryogenic liquid. Do not allow liquid oxygen to enter drains or sewers. If so advised, shut down any air conditioning or ventilating systems that may draw vapor or gas from the spill into other locations.

If it is essential to enter a cloud caused by nitrogen or argon (note: never enter one that could be rich in oxygen), then wear a self contained breathing apparatus provided you are trained and qualified to do so. A stand-by person, also wearing breathing apparatus must keep you under surveillance. If the release is oxygen, then your clothes could be saturated making them extremely flammable. If you suspect that you have been contaminated with oxygen do not go near any source of ignition for no less than 15 minutes. Ventilate your clothing; change if possible. A fire may occur at any time in the oxygen cloud, should it come into contact with highly combustible material.

## General Safety Instructions

When working with inert gases prevent contact of liquid gas, cold vapors, or "snow" with exposed skin. Prevent entrapment of liquid in closed systems. Use only in well ventilated areas. Compressed gas cylinders contain gaseous and liquid gas at extremely high pressure and should be handled with care. Use a pressure-reducing regulator when connecting to lower pressure piping systems. Secure cylinders when in use. Never use direct flame to heat a compressed gas cylinder. Use a check valve to prevent backflow into a storage container. Avoid dragging, rolling, or sliding the cylinders, even for a short distance. Use a suitable hand truck. For additional handling recommendations on compressed gas cylinders, consult the Compressed Gas Association Pamphlet P-1.



### CAUTION !

- Wear loose fitting gloves of impermeable material such as leather when working with cold liquid, solid, or vapor
- Safety glasses are recommended when handling high-pressure cylinders and in areas where vapors are discharged

Set-up gas cylinder in a well ventilated area. Keep cylinder away from sources of heat. Storage should not be in heavy traffic areas to prevent accidental knocking over or damage from passing or falling objects. Valve caps should remain on cylinders not connected for use. Segregate full and empty cylinders. Storage areas should be free of combustible material. Avoid exposure to areas where salt or other corrosive chemicals are present. Install carbon dioxide cylinders with the valve end up. See Compressed Gas Association Pamphlet P-1 for additional recommendations.

## 6.5.3 Installation Safety Recommendations

### Preventive Measures

The very first preventive measure is to inform all persons who handle or who use inert gases:

- Of the hazard represented by the refraction of oxygen in atmosphere
- Of the preventive means to be employed in handling the gases
- Of procedures to be observed should an accident occur

This information and training should be systematically and periodically reviewed in order to maintain an awareness with regard to these hazards. In particular, training in rescue work is fundamental since quickly improvised rescue, without the respect of a strict procedure, often proves to be ineffective, if not catastrophic (the rescue worker lacking foresight becomes a second victim). An annual program of training and rescue drills is recommended.

### Ventilation

Depending on the existing ventilation, amount of gas used and size of room where the unit is installed and operated, ventilation may be required. A local exhaust may be useful at the point of sources of possible gas vapors. Where low lying areas are not naturally ventilated vents should be situated to avoid higher than normal concentration. Hazards to be considered in confined spaces are:

- Limited access and exits
- Increased likelihood of gas accumulation through leaks
- Increased asphyxiation risk
- Fire and explosion hazard

To be considered as confined spaces are the inside rooms of a building, laboratory rooms, machine pits, culverts, basement trenches for piping. When working in confined spaces, it is advisable that operators and other personnel are fully aware of the hazards of oxygen deficiency and adopt the following practices:

- A fully documented permit to work system
- Personal and fixed oxygen analyzers
- Self contained breathing apparatus available for use and all personnel fully trained in its use
- Personnel harnesses and ropes
- Operation of the "buddy system"
- A system of fresh air ventilation and fume extraction

In the case of permanent presence of personnel in a room where there are risks of oxygen depletion mixture, ventilation must be maintained with at least 30mJ per hour per person. The volume of air introduced per hour must not be less than twice the enclosed space in question. Ventilation should never be carried out with pure oxygen, but solely with air.

### ***Testing of Oxygen or Gas Content***

At present, various types of oxygen analyzers are available, which are often simple and reliable to operate. Such a monitor should at least have

- A readout of the actual gas concentration
- A settable alarm threshold value
- An alarm output with an acoustic and optical alarm connected
- An error output that shows malfunction of the monitor

Ideally the monitor should be placed so that it can be read inside, as well as from outside, the room which has gas present. The selection of the type of apparatus depends on the nature of the work in the place to be monitored (temperature, multiple detectors, portable equipment, etc). The picture below shows such a monitor for CO<sub>2</sub>.



Testing the oxygen content is desirable, although attention must be drawn to the fact that an analyzer alone is not absolute protection. Such equipment can always malfunction, unexpectedly be out of adjustment or detectors can be improperly positioned. Testing of oxygen content should therefore only be considered as an aid to the detection of a lack of oxygen.

### **Work Permit**

For certain types of work, safety instructions and a special work procedure must be set up in the form of a work permit

### **Personnel Protection**

Depending on the type of work to be performed, and the layout of the premises, the decision to provide additional protection for personnel may be taken on the initiative of the person in charge. Such additional protection may involve:

- The use of notices warning against the presence of a hazard
- The placing of a person on watch outside the work area
- The use of personal atmosphere monitors
- The organization of an alarm system for rapid intervention in case of an emergency
- The wearing of a harness so that the worker can be easily and rapidly taken out of an enclosed space in the case of an emergency. Preferably this harness is connected to a hoist to facilitate removing the victim. It is very difficult for one man to lift up another in the absence of a hoist.
- The wearing of an autonomous breathing mask, to the exclusion of all cartridge masks, which are ineffective in a case of lack of oxygen.
- The wearing of protective goggles and gloves when handling liquid nitrogen to avoid burns
- The wearing of all other means of protection, such as safety shoes, helmet, etc., depending on the circumstances



Considering the hazards mentioned above, it is essential to provide all those who handle or use inert gases with all the information and training necessary regarding safety instructions, means of prevention and procedures to be followed to avoid accidents, as well as rescue procedures to be implemented in the event of an accident.

## 6.5.4 System Installation

On installations preferably choose pressurized cylinders rather than gas wall outlets. The use of cylinders will limit the amount of gas being spilled in case of fatal failure. Whenever a wall outlet installation is chosen, make sure that there is a remote shut off valve installed outside the room where the gas is used.

Place the cylinder in an easily accessible and visible place next to the incubator. Remember that the cylinder will have to be replaced routinely. As the operator will have to check the cylinder routinely it should be clearly visible to all personnel during routine work.

Install the instrument in a room with a glass door or a window that will allow a good view of the instrument and gas connection from outside the room. Often major defects can easily be detected by visible vapor clouds or icy tubes without the risk of entering a contaminated room.

Before installation make sure that the maximum specified inlet pressure is never exceeded. Always install a main shut-off valve that will cut gas flow as close to the source as possible. Secure cylinder when in use.



<b>WARNING!</b>
➤ Gas cylinders are under extremely high pressure that must be reduced for use with a StoreX incubator
➤ Use a pressure-reducing regulator when connecting to lower pressure piping system
➤ Never exceed maximum specified inlet pressure
➤ Never connect StoreX gassing inlet directly to a pressurized cylinder or wall outlet

Use a two stage pressure regulator with indicating valves. The high pressure gauge should have an indicating range of 0 to ~200 atm (0..3000 psi) to monitor the pressure of the gas source. For CO<sub>2</sub> a scale of 0..100 atm (0..2000psi) is sufficient. The low pressure gauge should have an indicating range of 0..4 bar (0..60 psi) and will monitor the input pressure to the StoreX. A flow meter is recommended since it will show correct operation of the system.

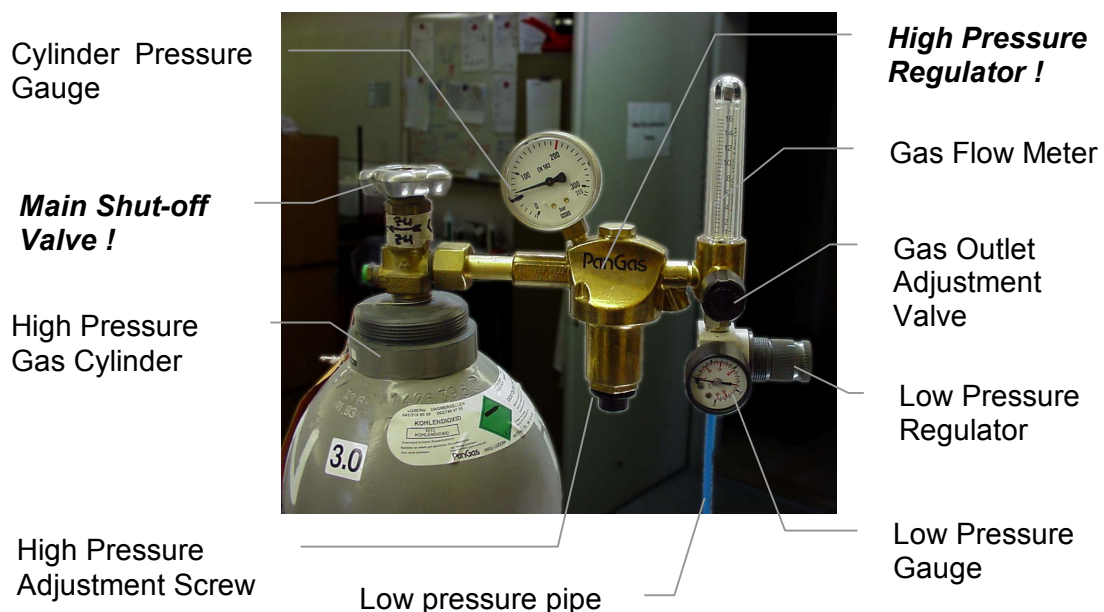



Two-stage pressure regulators are available from gas suppliers or laboratory accessories suppliers. The picture above shows an example of an installation. There is a wide variety of different models available. Your equipment may look different.

The gas inlet of the StoreX is located on the back of the instrument. Attach the CO2 low pressure hose securely to the fitting. Always use the security nut. Never operate the unit without the security nut being tightly fit.

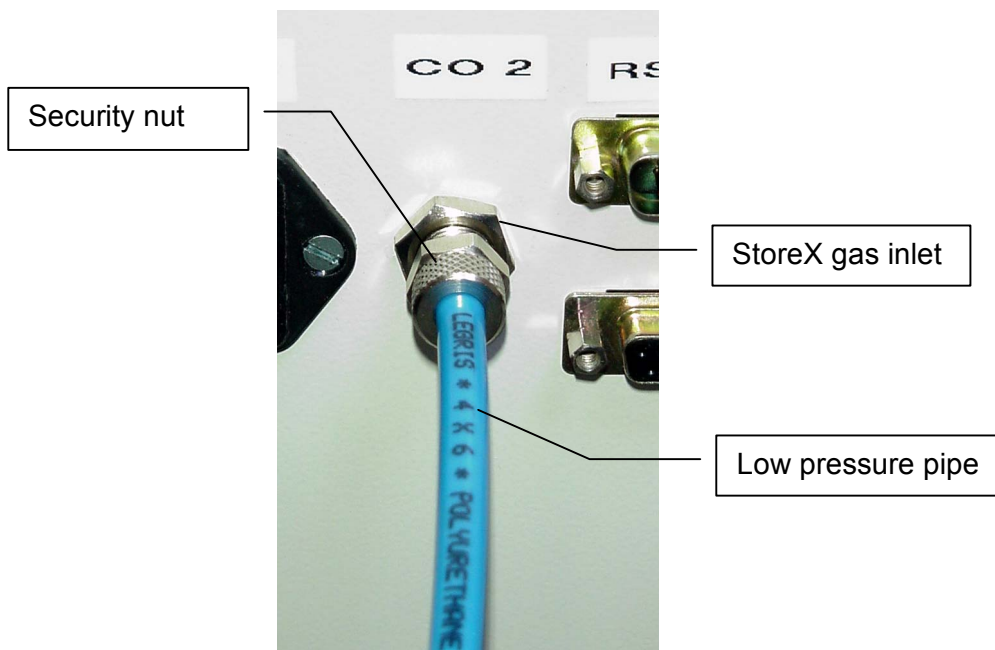

Use 4x6mm PUR, PVC, Neoprene or Nylon tube for the low pressure connection. Do not use Silicon or natural rubber tubing. Make the low pressure tube long enough to allow a minimum of movement of the StoreX for cleaning and maintenance work. For longer length of tubing, copper or other metal tubing should be considered. Foresee flexible tubing next to the instrument.

Be prepared for the following gas consumption values. These values may vary significantly over time since they depend on the instruments use.

## 6.5.5 Specific Advice for CO2 Carbon Dioxide

### *Principals of Operation*

CO2 is mainly used in cell-based assays. CO2 prevents changes in the PH-value of the probes. Although CO2 is not toxic several precautions must be taken in order to ensure safe operation.



#### WARNING !

- Improper use of CO2 or improper installation of the CO2 operated equipment may cause death
- Read CO2 safety information and installation instructions (See CO2 Installation) carefully. If you are not familiar with the handling of CO2 and / or safety precautions contact trained personnel.

### Properties of Carbon Dioxide

Carbon dioxide is colorless and odorless as gas or liquid. It is stored in containers under its own vapor pressure. If the pressure is suddenly relieved, the liquid rapidly cools as it evaporates and sublimates, forming dry ice at  $-78.5^{\circ}\text{C}$  ( $-109.3^{\circ}\text{F}$ )

Boiling Point @ 1 atm	$-78.5^{\circ}\text{C}$ , $-109.3^{\circ}\text{F}$
Freezing Point @ 1 atm	$-56.6^{\circ}\text{C}$ , $76.0^{\circ}\text{F}$
Vapor Pressure @ $20^{\circ}\text{C}$	56.5 atm, 831 psi
Solubility in Water @ $20^{\circ}\text{C}$ , 1 atm	87.8% vol.
Specific Gravity (air =1) @ $20^{\circ}\text{C}$ , 1 atm	1.53

### Health Hazard Data of Carbon Dioxide

Carbon dioxide is a minor but important constituent of the atmosphere, averaging about 0.03% or 300 ppm by volume. At higher concentrations it affects the respiratory rate. Additional symptoms are described below.



<b>WARNING !</b>	
➤	THRESHOLD LIMIT VALUE TLV = 5'000 ppm
➤	TLV-STEL (Short Term Exposure Limit) = 15'000 ppm (=1.5% vol.)

Carbon dioxide does not support life and may produce immediately hazardous atmospheres. At a concentration in excess of 1.5%, carbon dioxide may produce hyperventilation, headaches, visual disturbances, tremor, loss of consciousness and, death. Symptoms of exposure in the concentration ranges of 1.5-5% may be highly variable, but typical symptoms of carbon dioxide intoxication include the following:

CO <sub>2</sub> Concentration	Symptoms
3-6%	Headaches, dyspnea, perspiration, breathing increases to approximately four times normal rate, symptoms of intoxication become evident, and slight choking may be felt.
6-10%	Headache, dyspnea, perspiration, tremors, visual disturbance, characteristic sharp odor noticeable, very labored breathing and ringing in the ears, judgment may be impaired, followed within minutes by loss of consciousness.
Over 10%	Unconsciousness occurs more rapidly above 10% level. Prolonged exposure to high concentrations may eventually result in death from asphyxiation.

If the concentration of carbon dioxide exceeds 10%, unconsciousness can occur without warning, preventing self-rescue. At much higher concentrations, carbon dioxide displaces the oxygen in air below levels necessary to support life.

Persons suffering from the toxic effect of carbon dioxide should be moved to areas with normal atmosphere. Self contained breathing apparatus may be necessary to prevent toxic exposure or asphyxiation of rescue workers. Assisted respiration and supplemental oxygen should be given if the victim is not breathing. Frozen tissues should be flooded or soaked with tepid water ( $105-115^{\circ}\text{F}$ ;  $41-46^{\circ}\text{C}$ ). Do not use hot water. Cryogenic burns which result in blistering or deeper tissue freezing should be seen to promptly by a physician.

## 6.5.6 Specific Advice for O2 Oxygen

### *Properties of Oxygen*

Oxygen is the only gas, which supports life. The normal concentration in the air that we breathe is approximately 21%. The danger occurs when the oxygen levels in the air and the hazards of asphyxia become very great.

Boiling Point @ 1 atm	-183.0°C (-297.3°F)
Freezing Point @ 1 atm	-218.8°C (-361°F)
Vapor Pressure @ 25°C	N/A (cylinder ~200 bar typ.)
Solubility in Water @ 0°C, 1 atm	3.16% vol.
Specific Gravity (air =1) @-183°C, 1 atm	1.14

Gaseous oxygen is colorless and odorless. Liquid oxygen is pale blue and odorless. Oxygen is nonflammable, but supports and VIGOROUSLY ACCELERATES COMBUSTION of flammables. Some elastomers (o-rings, valve seats, etc.) are not compatible with oxygen. Cleanliness and compatibility of materials in contact with oxygen are therefore essential especially for internal parts of piping systems.

### *Health Hazard Data of Oxygen*

Oxygen is nontoxic under most conditions of use and is necessary to support life. However, breathing pure oxygen at one atmosphere, may produce cough and chest pains within 8-24 hours. Concentrations of 60% may produce these symptoms in several days. At two atmospheres symptoms occur in 2-3 hours. Partial pressure of oxygen in excess of two atmospheres may produce a variety of central nervous system manifestations including tingling of fingers and toes, visual and hearing disturbances, abnormal sensations, impaired coordination, confusion, muscle twitching, and seizures resembling those of epilepsy. Severe hazards may be present when confusion and impaired judgment lead to operational errors. Infants exposed to oxygen levels in excess of 35-40% may suffer permanent visual impairment or blindness due to retrolental fibroplasia.



#### WARNING !

- Materials which burn in air will burn violently in atmosphere richer by approx. 25% oxygen. Some materials will burn in pure oxygen which are nonflammable in air.
- Liquid oxygen or cold gas will freeze tissues and can cause severe cryogenic (extremely low temperature) burns.

Prevent contact of liquid oxygen with exposed skin. Prevent entrapment of liquid in closed systems. Use only in well ventilated areas. Open oxygen valves slowly. Compressed gas cylinders contain oxygen at extremely high pressure and should be handled with care. Never use direct flame to heat a compressed gas cylinder.

If cryogenic liquid or cold boil-off gas contacts a worker's skin or eyes, frozen tissues should be flooded or soaked in tepid water 41-46°C (105-115°F). DO NOT USE HOTWATER. Burns which result in blistering or deeper tissue freezing should be seen to promptly by a physician.

To fight fires, shut off sources of oxygen and use conventional firefighting methods. Prevent liquid oxygen from coming into contact with grease, oil, asphalt or combustibles. Ventilate area to evaporate and disperse oxygen. Flush area with large quantities of water. DO NOT ENTER areas of high oxygen concentration, which can saturate clothing and increase its flammability. Avoid smoking and contact with sources of ignition after exposure to concentration of oxygen higher than the normal atmosphere.

## 6.5.7 Specific Advice for N2 Nitrogen

### **Properties of Nitrogen**

Nitrogen is colorless, odorless and tasteless, as gas or liquid. It is nontoxic and non-flammable at atmospheric temperatures and pressures. A specific gravity of 0.9669 makes nitrogen slightly lighter than air. Nitrogen is mainly found in the atmosphere, where it accounts for 78.1% by volume of the air we breath. It is stored In containers under its own vapor pressure.

Boiling Point @ 1 atm	-195.8°C (-320.4°F)
Freezing Point @ 1 atm	-209.9°C (-345.8°F)
Vapor Pressure @ 20°C	150 atm
Solubility in Water @ 0°C, 1 atm	2.3% vol.
Specific Gravity (air =1) @ 20°C, 1 atm	0.97

### **Health Hazard Data of Nitrogen**

Nitrogen is inert and does not sustain life. Nitrogen is nontoxic, but may cause suffocation by displacing the oxygen in air.

Oxygen Concentration	Symptoms
21 - 14% (<19.5%) Oxygen	Increasing pulse rate, tiredness, dizziness, drowsiness, excess salivation, diminished mental alertness
14 - 11% Oxygen	Muscular coordination slightly disturbed, intellectual performance becomes difficult, breathing and pulse rate increased
11 – 8% Oxygen	Possibility of headaches, nausea and vomiting, collapse or loss of consciousness.
< 6% Oxygen:	Unconsciousness occurs without warning and so quickly that the individuals cannot help or protect themselves. Convulsive movements, possible respiratory collapse and death or brain damage

On sudden pressure release, liquid nitrogen rapidly cools as it evaporates and sublimates, forming dry ice at extremely cold temperatures of –196°C (-320°F) at atmospheric pressure. This can cause **severe frost bite**.



#### WARNING !

- Nitrogen may cause suffocation by displacing the oxygen in air. Ensure levels of *at least 19.5% Oxygen*
- On evaporation Nitrogen forms dry ice at *extremely cold* temperatures of –196°C (-320°F)

Nitrogen may cause mild skin irritation, moderate eye irritation and possible gastric distress. Cause of chronic illness is not known.

On vaporization Nitrogen expands by a factor of 700; one liter of liquid nitrogen becomes 24.6 cubic feet of nitrogen gas. This can cause the **explosion** of a sealed container, or it can displace oxygen in the room and cause **suffocation without warning**. Nitrogen can also become oxygen enriched and cause ordinarily noncombustible materials to burn rapidly.

In case of an accident evacuate all personnel from the affected area. Persons suffering from lack of oxygen should be removed to fresh air. If victim is not breathing, use trained personnel to administer a supplemental oxygen supply and artificial respiration to support vital functions. If breathing is difficult, administer oxygen. Victim and rescuers must seek immediate medical attention.

Ventilate area and attempt to shut off the release of gas by tightening the main valve. If it is not possible to stop the release of gas, allow the gas to be released there. If leaking from cylinder or its valve, contact your supplier. Monitor area for a minimum of 19.5% oxygen content before allowing re-entry by personnel.

In case of frostbite, restore tissue to normal body temperature, 37°C (98.6°F), followed by protection of the injured tissue from further damage and infection. Immediately place the frostbitten part in warm water (not to exceed 40°C) or wrap affected parts gently in blankets. Under no circumstances should the water be over 44°C (112°F), nor should the frozen part be rubbed either before or after re-warming. Remove or loosen clothing that may constrict blood circulation to the frozen area. In case of massive exposure, remove clothing while showering the area with warm water. Encourage victim to gently exercise the affected part while being warmed. Call a physician. The patient should neither smoke, nor drink alcohol.

## 6.5.8 Principles of Operation of Gassing Options

### *Continuous Flow System*

The Continuous Flow System is the simplest implementation of the gassing option. The use of this solution is limited to low-accuracy applications where the incubation chamber has to be filled with a specific gas or where a gas inside the chamber has to be displaced. In some applications pre-mixed gas may be used. The gas flow is adjusted to a value that generates the specified atmosphere. This value is determined experimentally by the user. In most cases the low costs of this solution will quickly be compensated by the costs caused by the excessive gas consumption and / or additional safety requirements needed in conjunction with this solution.

A pressure limiter and a flow limiter protect the system from inlet pressure fluctuations and make it relatively insensitive to the amount of input pressure. This solution is adequate for very low demanding applications and for non toxic gases. Note that a significant amount of gas may be emitted to the instrument's environment.

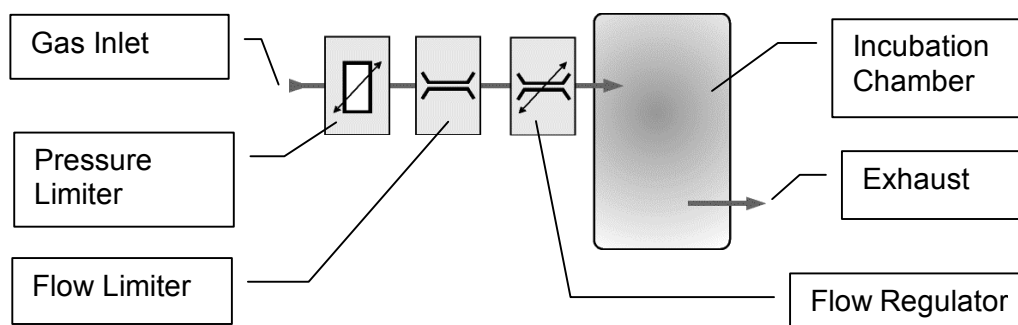

An exhaust channels the surplus amount of gas to a defined point. The exhaust is usually connected to the slightly under-pressurized exhaust system of the building. The flow regulator is combined with a visual flow indicator and a scale calibrated in l/min.

### Open Loop System

The Open Loop System uses a more intelligent system that limits gas flow to the actual required amount. This solution is suitable for mid-accuracy applications where the incubation chamber has to be filled with a specific gas or where a gas has to be displaced. In applications where a certain concentration has to be maintained pre-mixed gases may be used. The advantage of this solution over the continuous flow solution is its lower gas consumption while still maintaining low costs.

The picture below explains the functioning of this system. At the gas inlet a pressure limiter and a flow limiter protect the system from inlet pressure fluctuations. This also makes the system relatively insensitive to the amount of input pressure.

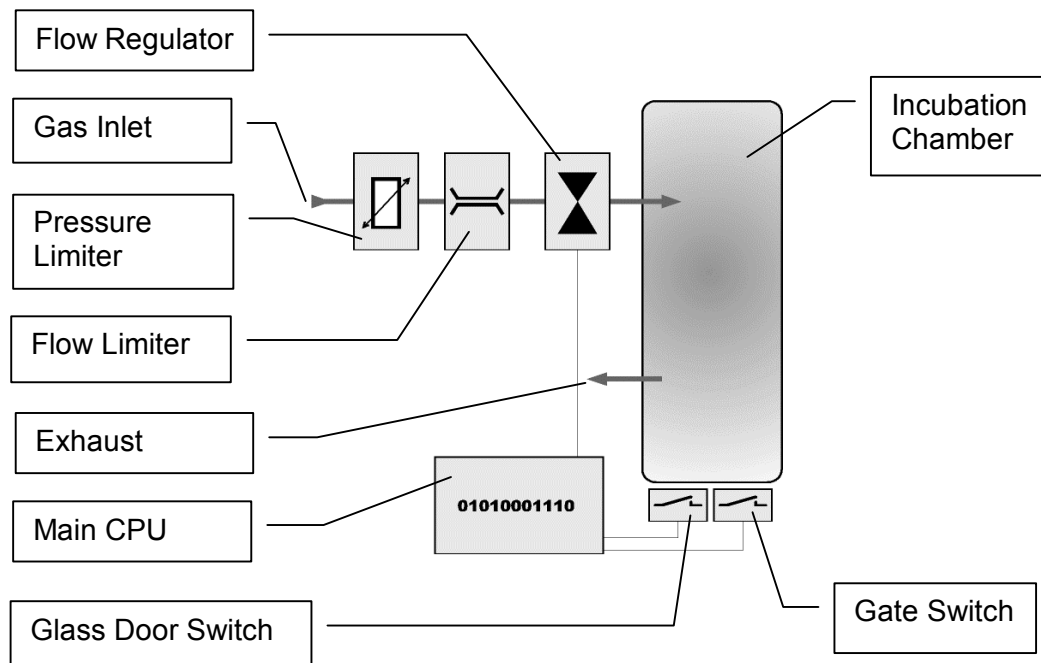

The actual gas flow is controlled by a solenoid. The solenoid is controlled by the main CPU. By sensing both, glass door switch and Gate switch, the CPU knows when there is a user access or when the Gate is opened and reacts accordingly. In fact the CPU holds three values that represent the gas needed to add. The standby value maintains the gas concentration when there is no access and compensates for minor leakages of the incubation chamber. The Gate Access Value compensates the gas loss caused by a Gate access while the User Access Constant allows recovery after opening the glass door. The CPU internally calculates the actual amount of gas needed in a specific situation. Since this system limits the gas consumption to a fairly low level the exhaust does not have to be connected in most cases.

## Closed Loop System

The Closed Loop System is the most advanced system that gives a very high level of accuracy and maximum flexibility. The gas consumption is limited to the actual required amount. This solution is suitable for high-accuracy applications where the incubation chamber has to be filled with specific gas concentrations that may even vary with time. In addition this solution provides an external and remotely readable readout of the actual gas concentration inside the incubation chamber. Gas concentration can be set or altered remotely.

Right at the inlet a pressure limiter protects the successive components against overpressure, up to ~10 bar. The pressure limiter also makes the gassing option relatively insensitive to the amount of inlet pressure. A flow limiter also limits the gas flow to ~10 l/min. A solenoid controls the gas flow to the incubation chamber in accordance with the gas concentration inside the chamber.

A second tubing system measures the gas concentration inside the incubation chamber. A pump removes a small amount of gas from the incubation chamber and feeds it to the gas sensor. A particle filter protects the pump and sensor from contamination.

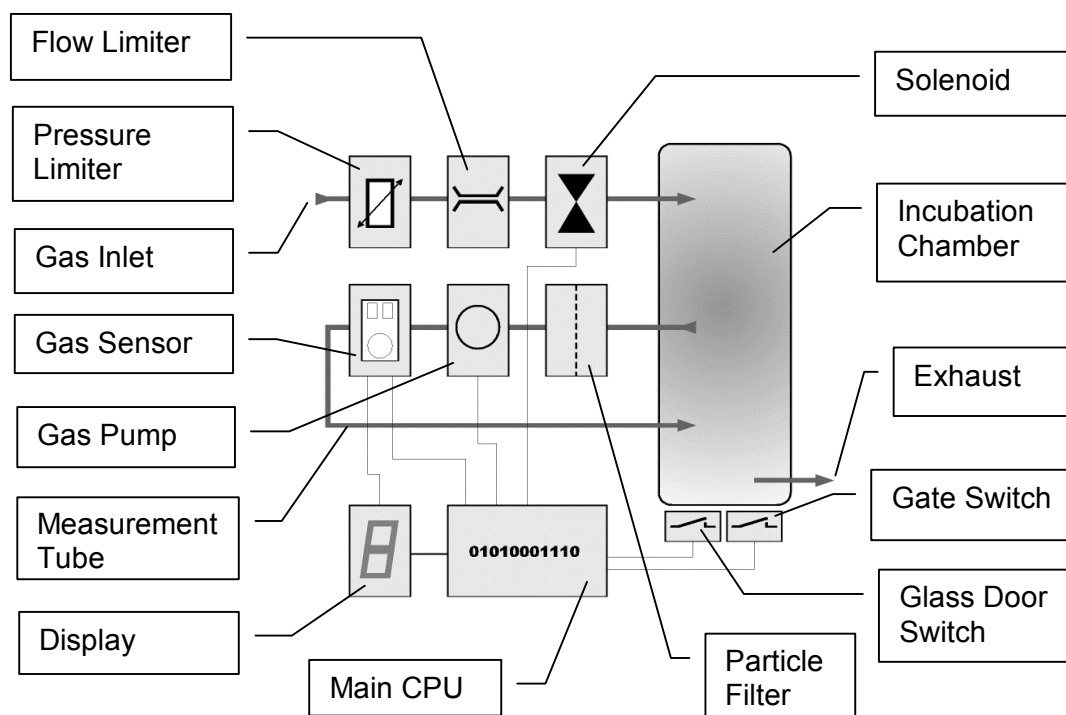

The main CPU monitors the opening of the incubation chamber preventing unwanted gas flow to the surrounding environment. The solenoid is therefore only opened when the glass door is shut and the Gate has not been opened over an excessive period of time.

## 6.5.9 Integrated StoreX Gassing Safety Features

There are a number of safety mechanisms implemented in the StoreX application that protect the user from unwanted exposure to gases.. Even in the case of failure or operation errors these mechanisms can ensure safe shut-off of the gas inlet. The optimum arrangement should be selected according to the level of accuracy, danger and specified settling time. The level of safety depends on the type of gassing option.

The continuous flow system has a minimal of safety functions. The exhaust limits gas leaking into the surrounding environment. A slight underpressure on the exhaust will also lower uncontrolled gas flow into the surrounding environment. The safety elements of the continuous flow system simply limit the gas flow and protect against overpressure to some extent. This system may not be used in an higher risk environment.

A significantly higher standard of safety is provided by the open loop.system. In addition to the basic flow and pressure protection, the gas flow is by the system. This results in a significantly higher level of safety and in a reduction of gas consumption.

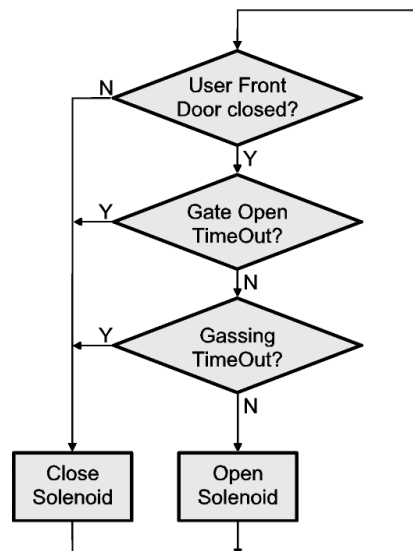

The above flowchart lists the steps that are implemented to avoid unwanted gas emissions. As a first step the gas is always shut-off when the glass door is open. This will eliminate the risk of large amounts of gas exiting when the user door is opened. The same applies to the Gate. However, because of its smaller size some gas flow is allowed even when the Gate is open. A Gate timeout is implemented cutting gas flow when the Gate has been opened for an excessive period of time. An additional general safety step is the gassing timeout. A gassing timeout will occur when the solenoid is opened over a limited period of time.

An even greater level of safety can be achieved by the closed loopsystem. By actually measuring and displaying the gas concentration possible errors or malfunctions can be detected by the system. If the specified gas concentration is not reached within a certain time limit the gas flow is shut-off and a error flag is set. A display will inform the operator as to the correct operation of the system.



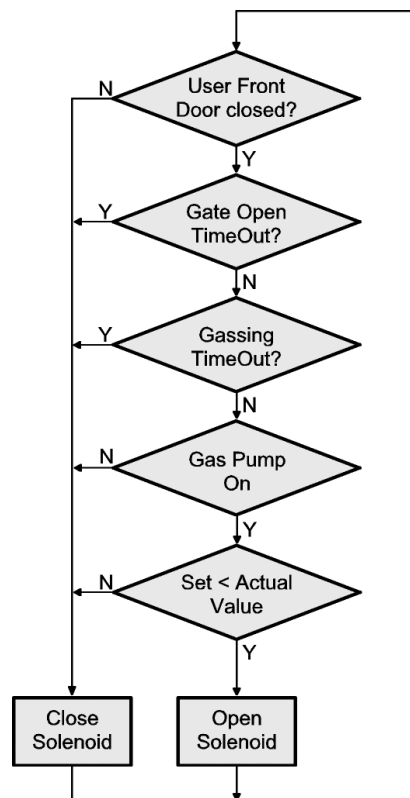

The option of remote access to the gas concentration allows a simple tracing of the gas concentration over long periods of time.

The safety features are summarized in a table given below.

Feature	Comment	F <sup>1</sup>	O <sup>2</sup>	C <sup>3</sup>
Pressure Limiter	Limits internal pressure to some extent	+	+	+
Gas Flow Limiter	Limits maximum flow avoiding full gas flow	+	+	+
Exhaust	Channels exhaust gas	+	+	- <sup>4</sup>
Gas Switch	Turns gas flow on and off	-	+	+
Door Monitoring	Cuts gas flow when door opens	-	+	+
Gate Monitoring	Cuts gas flow when Gate is open over a certain period of time	-	+	+
Gas Flow Timeout	Cuts gas when a continuous gas flow occurs over a long period of time	-	+	+
Gas Flow Lookup	Controls gas flow according to system status	-	+	+
Gas Control	Controls gas flow according to measured gas concentration values	-	-	+
Gas Measuring	Gas sensor measures actual gas concentration	-	-	+
Gas Display	Gas concentration is displayed to user	-	-	+
Gas Transmission	Remote gas concentration readout	-	-	+



**WARNING!**

- Because of the high safety standards maintained within the StoreX the highest risk of failure or unwanted gas emission lies in the external installations

<sup>1</sup> Continuous Flow System  
<sup>2</sup> Open Loop System  
<sup>3</sup> Closed Loop System  
<sup>4</sup> Available on request

## 6.6 About other Hazardous Substances

### 6.6.1 DMSO (Dimethyl Sulfoxide)

#### ***Properties of DMSO (Dimethyl Sulfoxide)***

DMSO (Dimethyl Sulfoxide) is often used in cooled dry storages like the StoreX DC. DMSO is used in the synthesis of important pharmaceuticals such as Ranitidine, Clarithromycin and Ioversol. Important herbicides made with DMSO are: acifluorfen, oxyfluorfen, lactofen and haloxyfop. DMSO is a clear, colorless liquid with a garlic/onion-like odor that is quickly absorbed through the skin and is capable of transporting other dissolved chemicals or dissolved toxins into the body.

Boiling Point @ 1 atm	189°C (372.2°F)
Freezing Point @ 1 atm	18.4°C (65.1°F)
Vapor Pressure @20°C	0.556 mbar
Solubility	DMSO is totally soluble in water, light alcohols and diethylether
Flash Point	88°C (190°F)
Auto-ignition Temperature	215°C (419°F)
Lower Explosion Limit	48.5% vol. in air
Upper Explosion Limit	2.6% vol. in air
Specific Gravity	1.104

#### ***Health Hazard Data of DMSO***

The main danger of DMSO lies in its ability to transport dissolved chemicals into the body. DMSO can cause itching, redness, scaling and hives on the skin. DMSO can cause irritation in the case of eye contact. Inhalation may cause respiratory tract irritation, headache, nausea, dizziness and drowsiness. Ingestion will lead to dizziness, drowsiness, nausea, vomiting, cramps and chills. Long-term or delayed effects are damage to the liver and kidneys.

In the case of accidental contact of DMSO with the skin remove contaminated clothing, rinse skin thoroughly and contact a physician. Should DMSO get into the eyes rinse thoroughly with water and contact a physician. After accidental inhalation move victim from exposure area to fresh air. If breathing has stopped artificial respiration should be administered. Seek professional medical assistance. On ingestion contact a physician immediately. Do not induce vomiting.

DMSO has unusual fire and explosion hazards. Under fire conditions DMSO emits toxic fumes. DMSO undergoes a violent reaction in mixing with a wide variety of materials such as copper, wool, chloride, silicon. When heated to above its boiling point DMSO degrades, giving off formaldehyde, methyl mercaptan and sulfur dioxide.

Wear a respirator, chemical safety goggles, rubber boots and heavy rubber gloves. Ventilate area and wash spill after material pickup. Avoid contaminating water supply. For personal protection a mechanical exhaust, safety shower and eye bath is recommended. Wash thoroughly after handling of DMSO. Do not breathe in vapor.

Store tightly closed in a cool and dry place. Keep away from heat and open flames.



WARNING !
➤ DMSO is quickly absorbed through the skin and is capable of transporting other dissolved chemicals or dissolved toxins into the body
➤ DMSO has unusual fire and explosions hazards

## 6.7 Noise sound level

The StoreX creates no noise in heating mode. When in refrigeration mode the maximum noise measured is less than 85 dBA reference sound pressure of 20 uPa. Excise normal precaution about noise. No special protection is required. However special means e.g. protective earpieces can provide higher level of protection and comfort to the operator.

## 7. Manual Operation

### 7.1 Routine Safety Checks

Carefully read all Safety Instructions before operating the instrument. Be sure that you fully understand their content. Although the StoreX is intended to be operated as a remote controlled system there still are some manual interactions required for operation. Apart from these operations there are also some very important safety checks the operator should be familiar with.

The Operator should regularly read the display readings and check whether they match the desired values. Readings like “0.00” or “9.99”, readings that are far out, instable or that differ over long periods of time could indicate a malfunction of the instrument or could be caused by faulty settings of the system. Through remote data readings the implementation of a climate quality monitor is simplified.

The electrical cables should be routinely inspected for wear, defects or contusion. There should not be mechanical tension on any cable. Broken connectors should be replaced immediately. All electrical installations should be kept clean and well protected from water and humidity.

The same applies to cables and gas tubing. They should be free of mechanical tension and should show no signs of wear or contusion. Sharp bends should be avoided under all circumstances. All fittings should be secured. Missing security nuts must be reinstalled immediately. Any broken pneumatics parts must also be replaced immediately.

The mechanical appearance of the instrument should be clean and “straight”. All movements should be smooth and precise. Watch out for unusual noises as these may indicate misalignments or mechanical wear.

Seals should close the incubation chamber firmly. Check seals by placing a piece of paper between the seal and door. When trying to pull on the paper there should be an even resistance. Check the seal on the Glass Door, Gate and Front Door.

Condensation, mainly on the front glass door, presents a possible severe danger as it may lead to water flowing into the electrical parts of the instrument. When cooling, excessive condensation on the glass door will occur when the Front Door is open over a long period of time or it may indicate a faulty heater or high environmental humidity. Condensation in heating mode may be caused by defective seals.

Localized changes of color may indicate overheating.

Icing on a gassing tube or on a pressurized gas cylinder indicates excessive gas flow and therefore severe danger. Once icing has been observed leave the room immediately and call for help. Do not try to locate the source of the problem or try to fix it. The room may already be contaminated.



#### WARNING!

- Icing on the gas cylinder or other parts of the gassing system indicate excessive gas flow
- In the case of such icing leave the room immediately and call for help
- Do not try to locate the source of the problem or try to fix it

## 7.2 Front Door

The Front Door opens on the left side of the instrument and should be kept closed at all times. A Magnetic Seal keeps the Front Door closed. When access is necessary it should be for as short as possible periods.

In order to avoid condensation and to allow an even temperature distribution inside the instrument, the Front Door is heated. Note: Leaving the Front Door open for extended periods will influence the instruments temperature.

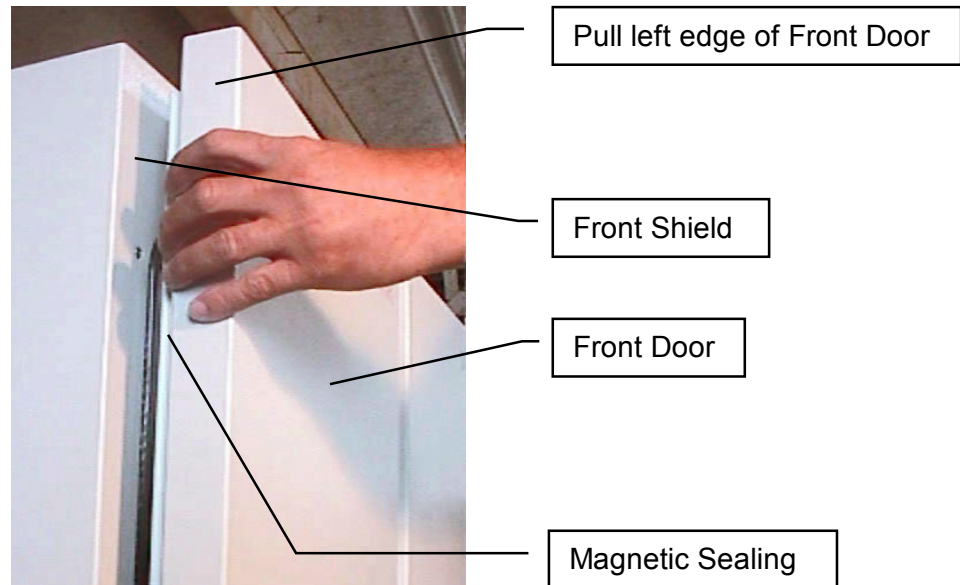

The Front Door is opened by pulling on the left edge and may be opened to an angle of almost 180 degrees when standing alone. When placed next to another StoreX unit the Front Door may be opened by approximately 100 degrees.

Regularly inspect sealing performance of the Front Door. The Magnetic Seal must keep the Front Door firmly closed over its whole surface. When the Front Door is out of alignment with the Front Shield it must be re-aligned by an authorized person. Note that gaps between the Magnetic Seal and Front Shield will cause undesired air exchange and therefore condensation and will degrade the temperature distribution.



### CAUTION !

- Use left edge of Front Door to open Front Door
- Keep Front Door closed when it is not being accessed
- Keep Front Door Access to a minimum
- Magnetic Seal must firmly close Front Door
- Keep Magnetic Seal clean



### WARNING !

- It is dangerous to leave the Front Door open over long periods of time.
- Avoid excessive condensation on the glass door

## 7.3 Glass Door

Behind the Front Door is the Glass Door which allows inspection of the stored samples and observation of the functioning of the Handler while keeping the climate stable.

The Glass Door may be opened on its left side but should be kept closed at all times. When access is necessary, the Glass Door should only be opened for as short a time as possible. A Glass Door Access will dramatically influence climate inside the instrument. Humidity and CO<sub>2</sub> are extremely sensitive to these accesses.

The Glass Door is sealed by an Inner Seal. The Inner Sealing completely isolates the Climate inside the Climate Chamber from the ambient climate. Gas exchange between the Climate Chamber and the exterior is practically eliminated.

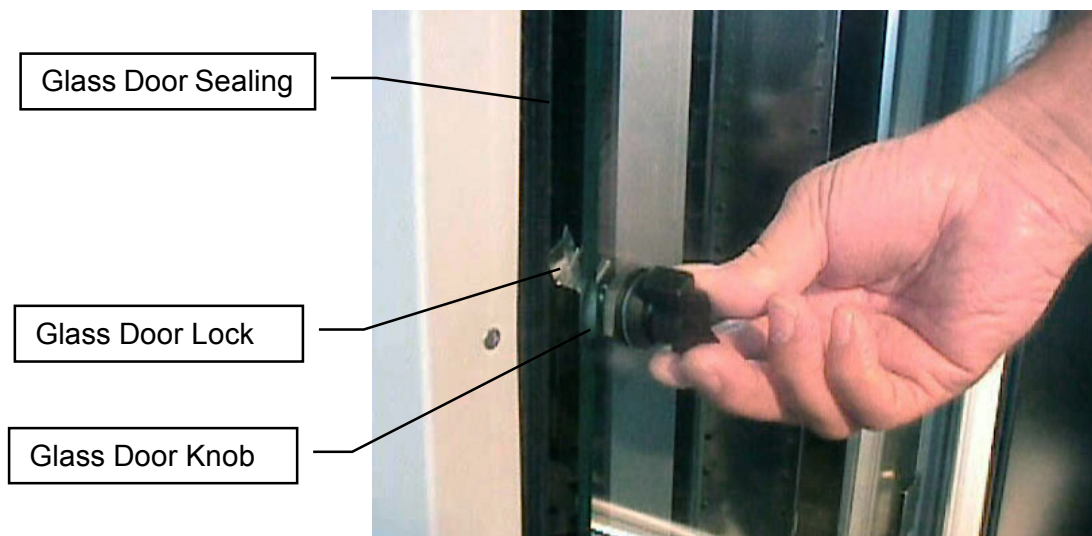

When a Glass Door Access exceeds a certain time period an alarm will sound. This alarm will also prevent the Glass Door from being left open unintentionally. The alarm may be stopped by closing the Glass Door.



### CAUTION !

- Rotate Glass Door Knob clockwise to open Glass Door
- Keep Glass Door closed all the time during critical processes. Opening the Glass Door will dramatically change climate in Climate Chamber and may destroy substances
- Keep Front Door Access to a minimum
- Regularly inspect Glass Door Seal
- Glass Door Lock must firmly close the Glass Door
- Keep Inner Seal clean

On instruments with an integrated carousel you may press the Multi Function Switch. This will activate the carousel. When the desired carousel position is accessible you may open the Glass Door. You may also simply open the glass door and spin the carousel it manually. The carousel power is switched off when the glass door is opened.

When you open the glass door during a remote access, the beeper will inform you about the conflict. In this case you should close the glass door again and wait until the remote access is finished. Or pause the remote accesses.

## 7.4 Stackers

Stackers allow for simple and comfortable loading and unloading of storage samples and can be prepared outside the climate chamber. Once prepared the samples can be quickly transferred into the climate chamber of the StoreX unit.

There is a wide variety of stacker types available. Make sure that you work with the proper stacker size that matches the type of plates you are using.



### CAUTION !

- Do not add, bend or remove microplate support rails.
- If you remove a stacker whose platform configuration is set up to receive Half-heights or Deep Well Plates, make sure it is put back in exactly the same position. Failure to do so will result in destinations not found or crashes.
- Only a trained System Integrator may alter the instrument configuration and reset the lift accordingly.

The stackers are open at their front for loading.

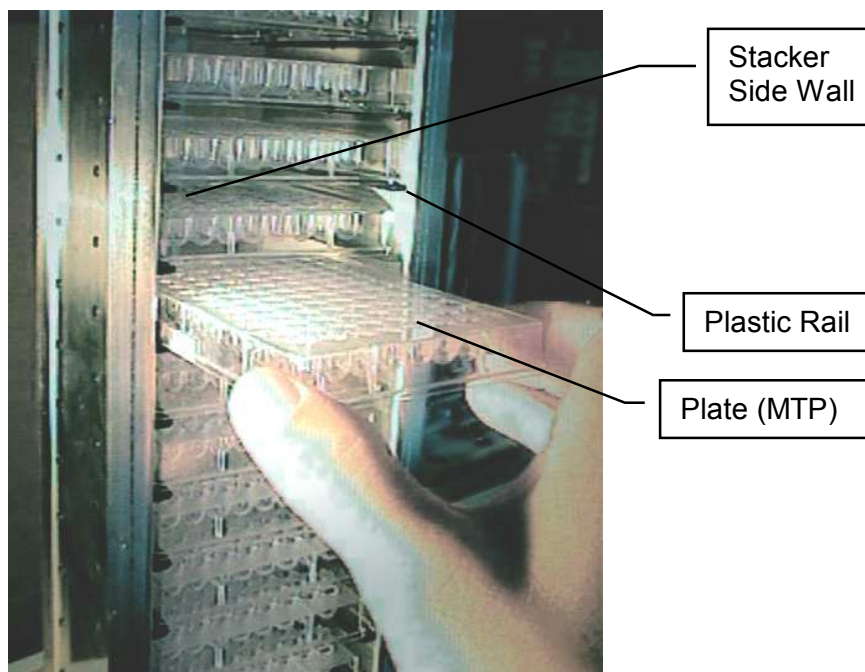

To put a plate in the stacker choose the level and slide the plate along the rails towards the back of the stacker. Slightly lift the front of the plate to avoid excessive wear of the retaining nozzles at the front end of the rails. When the plates are loaded make sure that they are all pushed towards the back of the stacker. Plates that jut out may cause collision with the handler and may result in damage to the handler.

Stackers must be treated with great care. They are aligned within 1mm when leaving the factory. Misaligned stackers must be returned for re-alignment. Misaligned, tilted or bent stackers are frequent causes for handling failures. Special care must be taken when stackers are fully loaded with plates.

The stacker plate must be kept clean as particles may cause it to tilt. Do not place stackers on the floor as they may pick-up dust etc. Always store stackers inside the climate chamber or on clean surfaces.

Use stacker handle for transport. When lifting the stacker by its handle it will tilt backward slightly in order to prevent plates from shifting to the front.

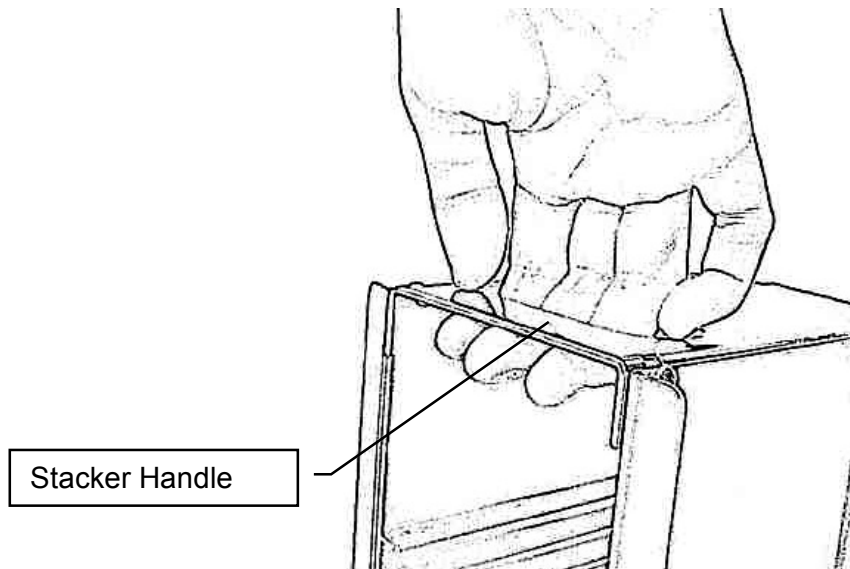

Never apply force to the stackers. Do not drop stackers as Mechanical shock will misalign the stacker. Never lift a stacker by its side walls for this may bend the side walls of the stacker. Bent side walls cause the plates to block when being loaded or unloaded.

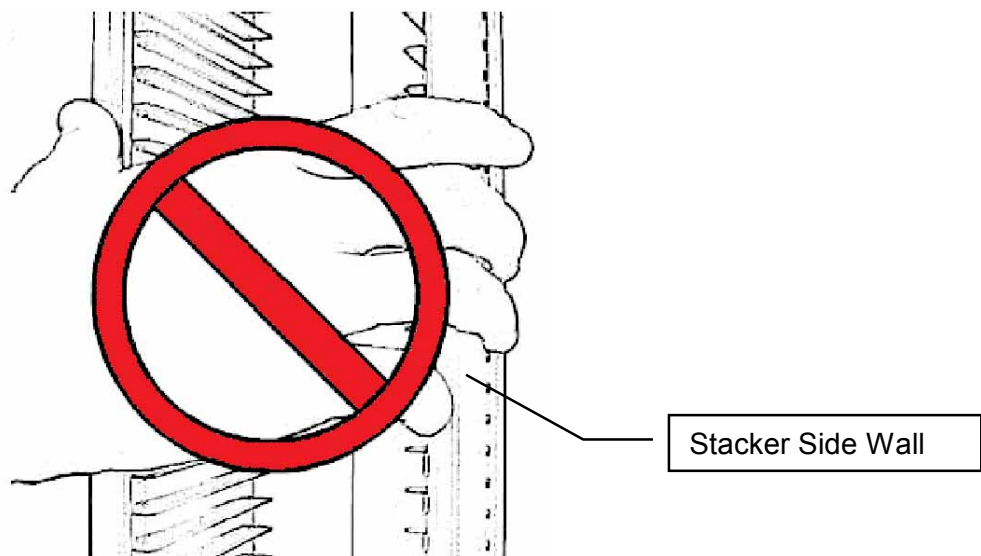

In the rare event of a blockage with the extended shovel in the stacker, the shovel must be carefully pushed backwards until it can move freely, then the stacker can be removed.



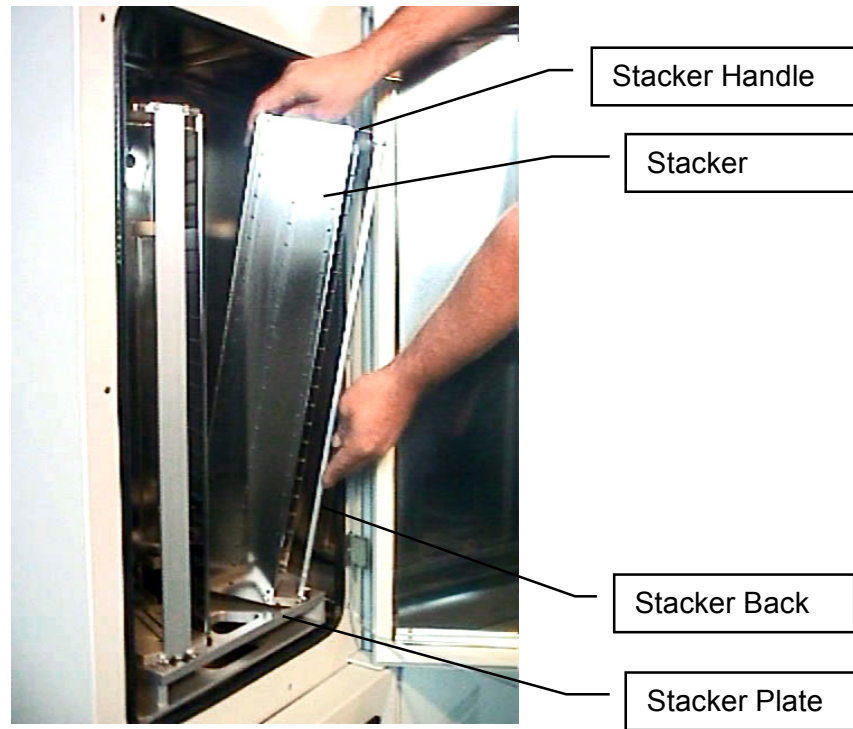

The stackers are secured by alignment rails to the stacker plate. The stackers may be tilted slightly backwards (towards the front opening) for removal. In order to load a stacker align the back of the stacker base plate to the centering pins located on the stacker plate. Push the stacker forward until it stands vertically. The stacker should now stand firmly on the stacker plate. There should be no movement.

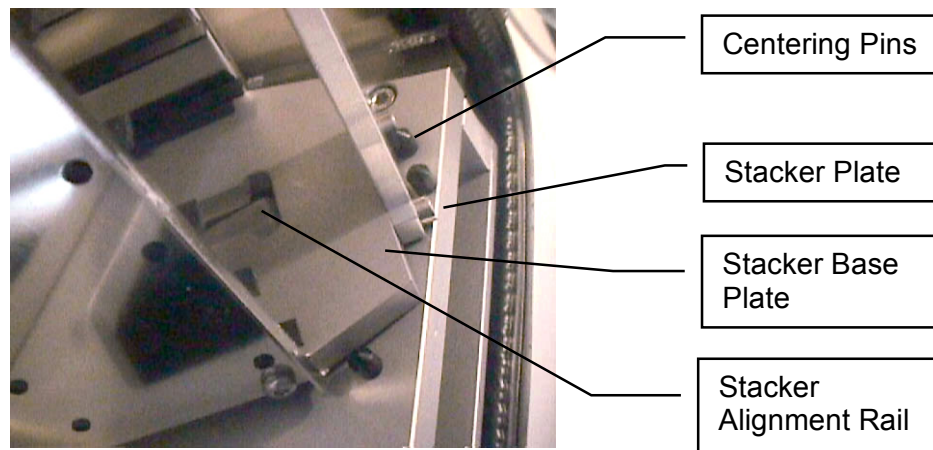

To remove a stacker pull the stacker handle slightly backwards, tilting it, then lift the stacker until it loosens from the stacker alignment rail. Use both hands for this operation. Never use force.



**CAUTION !**

- Make sure that ALL plates are pushed to the back of the stacker. Plates jutting out the front side of the stacker may cause collision with the handler shovel.
- Lift stackers by their stacker handles only
- Do not drop stackers. Misaligned stackers can cause handling errors
- Do not autoclave stackers. Use disinfecting solution for sterilization.
- Keep stacker plate clean. Particles may tilt stackers

## 7.5 Bar Code Reader

An optional Barcode Reader for microplate identification is mounted above the lift. Stacker shelf positions can be altered to hold 11 Half-heights or 7 Deep Well plates. However, this must be carried out by a trained System Integrator.

The Barcodes must be placed on the shorter side of the plates and must face towards the open side of the stacker. The barcodes should be parallel to the plate's lower edge. The barcode label should be centered both vertically and horizontally. On higher plates (e.g. deep well plates) place the barcode further down. Preferably barcode labels should be at the same height independent of the plate height. Make sure the barcode is not covered by the plate's lid.



**WARNING !**

- Laser Class 2. Laser light - do not look into the beam.



**DANGER !**

- May be harmful to your eyes.

Use barcode testing device to verify barcode quality. Quality Class A, B or C are required. Identification of Class D is not guaranteed. For sufficient print quality use barcodes printed by thermal - transfer or photographic methods. The barcode label surface should be mat and clean. Do not use yellowed, dirty or damaged barcodes

## 7.6 The Robot Gate

The Robot Gate is located on the rear side of the instrument. Through the Robot Gate the storage samples are transported by the Handler. The Robot Gate has the same sealing system as the Front Door. Because of the frequent accessing through the Gate, special care must be taken with the sealing performance of the Gate.

The Gate may make spontaneous movements. External commands, manual interaction and internal protection time-out functions may cause the Gate to close. Special care must be taken that the Gate cannot be accessed during operation.



**WARNING !**

- Remote Accesses have priority over manual accesses
- The integrator has to make sure that no remote access is initiated during a manual access (Always check Ready Bit prior to sending a command)

The Gate movement is speed and force controlled. However, the high demands on the sealing capability of the Gate require certain minimum forces, therefore there is a risk of injury. Never put hands into the Gate opening when the instrument is active.



**WARNING !**

- The Gate cannot be opened manually. Do not apply force to Gate.

On instruments with internal carrousel a positioning key located in the front panel of the incubator is pressed for manual access. In order to accept a manual positioning, the key-switch next to the positioning switch has to be in the right position.

## 7.7 Humidity Reservoir

Distilled water, HC, IC not DC.

Liquid Capacity of StoreX Incubators

STX40	IC, HC, HR	3.5 liters	0.5 liters
STX100	IC, HC, HR		
STX200	IC, HC, HR	7 liters	0.75 liters
STX500	IC, HC, HR	7 liters	0.75 liters
SXT1000	IC, HC, HR		

Fill water as shown on the picture below. Never fill dry units such as DC or DR models.



### CAUTION !

- Do not overfill reservoir
- Do not spill water on front panel
- Use distilled and sterilized water
- Never fill dry StoreX models

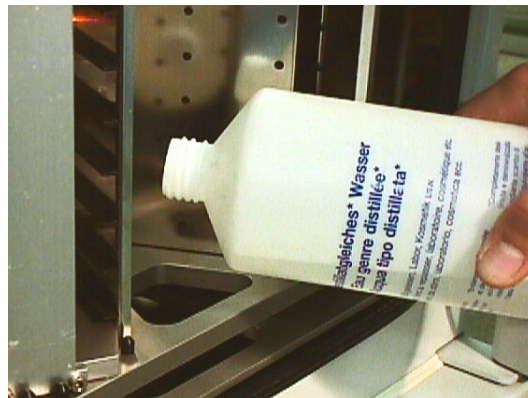

Level-indicator

## 7.8 Power-On System

The Instruments power is activated by the incubator's main switch. The instrument is turned on by pressing the power switch located at the front of the instrument. After power-on the climate portion of the instrument is activated automatically. An alarm will sound. If the green light of the Power Switch does not turn on, check the Main Switch at the back of the instrument.

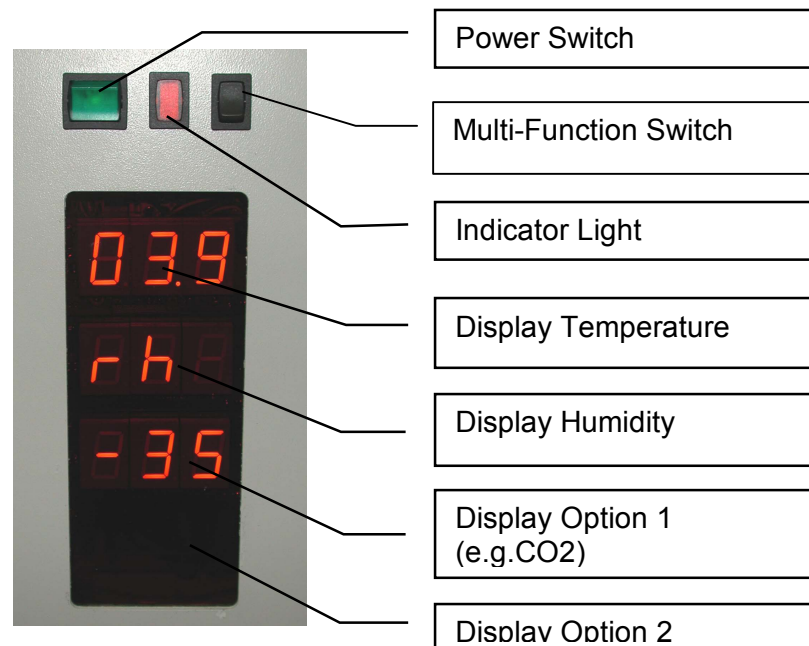

The alarm indicates that the handling is not activated. In order to activate the handling, the red Start Switch has to be pressed. The Start Switch will cause the handling to initialize. Take note whether the Gate - if opened- is closed after pressing the Start Switch. Pressing the Start Switch is equal to sending an external Activate Command through the Communication Port.

It is normal for some condensation to occur during warm-up. This condensation will disappear once the internal climate is stabilized. The settling time may take several hours.

The temperature inside the Climate Chamber is displayed on the Temperature Display. The Temperature Display may not be used to set Temperature. The Operating Temperature can only be set through the Communication Port.

## 7.9 Alarm System

The StoreX has a combined acoustic / visual alarm system. An alarm occurs when one or more abnormal statuses occur or when interaction is required. When the system is operating properly there is no alarm. The various alarms are distinguished by the alarm signal duration and the pause between the signals. The following alarms are defined:

Signal / Pause (time in seconds)	Alarm	Comment, Action
0.1 / 2.4	No Initialization	StoreX not initialized. Press knob for initialization.
0.1 / 0.3	Gate Timeout	Check Handling position. Press knob to close Gate.
0.2 / 0.4	Glass Door Timeout	Close Glass Door or press knob to cancel alarm.
0.3 / 30	Water Level Low	Refill water or press knob for at least 3 seconds to cancel alarm.
0.5 / 0.5	Access collision	Occurs when Glass Door is opened and shovel is extracted. This alarm indicates high risk of damage to the handler. Do not rotate carousel. Check shovel position before moving stackers. Use extreme caution as shovel may be trapped in stacker.
0.1 / 0.1	System Busy Access	Glass Door is opened during a remote access. Close Glass Door and wait for remote access to be finished.

## 7.10 Temperature Settings

The temperature of the instrument has to be set prior to Startup. Maximum temperature is 50°C or 70°C in instruments with High Temperature HT option as higher temperatures may damage the handling drives. For the incubator temperature adjustment procedure consult the remote communication chapter of this manual.



### WARNING !

- Maximum incubator temperature is 50°C (70°C where specified)
- Adjust temperature prior to first startup.

Manual access is limited to the positioning of the carousel. The Robot Gate cannot be activated manually.

## 7.11 Cleaning



### WARNING !

- Do not touch handling or interior with bare hands
- Some components of the handling may cause injuries
- Beware of open gears and sharp edges
- Do not perform cleaning operations if you did not receive adequate training
- Do not perform cleaning unless you are familiar with the content of the incubator

## 7.12 Disinfecting



### WARNING !

- Do not touch handling or interior with bare hands
- Some disinfecting fluids may be poison and / or cause irritation of skin
- Incubator contamination may be poison
- Wear glasses and gloves when working with disinfectants

## 7.13 Defrost

Use a towel to defrost the StoreX as is shown in the picture bellow.



## 8. Remote Operation

### 8.1 RS-232 Serial Port Configuration

ASCII data format  
 Full duplex  
 PC: Delimiter CR (Chr 13h)  
 PLC: Delimiter CR,LF (Chr 13h,10h)  
 9600 Baud  
 8 Data bits  
 1 Stop bit  
 Parity even

The example program shows how the comport is initialized under MS-DOS. For details refer to the MS-DOS manuals.

```

FUNCTION STX_InitCom (pN: INTEGER) : INTEGER;
VAR n: INTEGER;
BEGIN
    n:=ModeCom (pN, 9600, 'E', 8, 1);
    STX_InitCom:=n;
END;
  
```

## 8.2 Communication Fundamentals

### 8.2.1 Command Syntax

The hardware level communication is based on only a few commands. A command is an ASCII-string which is sent to the controller. Response is an ASCII string sent by the controller. Note that each command is prompted by a Response string.

A command consists of command segments. The first command segment defines the intention of the command. Command segments are separated by Space (ASCII 20h). Response Segments are separated by comma (ASCII 1Ch). The table below gives a list of abbreviations for the low level communication.

Command Segment	Mnemonics
Communication Request	CR
Communication Quit	CQ
Communication Clear	CC
Communication Finished	CF
Set	ST
Reset	RS
Read	RD
Write	WR
Write Set	WS
Data Memory	DM
Timer	T
Space ASCII 20h	<i>sp</i>
Line Feed ASCII 0Ah	<i>lf</i>
Carriage Return ASCII 0Dh	<i>cr</i>

## 8.2.2 Open / Close Communication

Prior to communication with the controller, the communication has to be opened. Before communication is opened, the controller only accepts the Open Communication Command (CR). For improved safety, it is recommended that communication is closed (CQ) when no communication is required for a long period of time.

	Command	Response
Open Communication <i>Send Commands (see below)</i>	CR <i>cr</i>	CC <i>cr lf</i>
Close Communication	CQ <i>cr</i>	CF <i>cr lf</i>

## 8.2.3 Hardware communication Error Responses

The following Error Codes are sent by the PLC. These error codes indicate system-errors and are not the same as the Instruments own error-messages (refer to "Handling Error Messages")

Error	Comment	Response
Relay Error	Undefined timer, counter, data memory, check if requested unit is valid	E0 <i>cr lf</i>
Command Error	Invalid Command, check if communication is opened by CR, check command sent to controller, check for interruptions during string transmission	E1 <i>cr lf</i>
Program Error	Firmware lost, reprogram controller	E2 <i>cr lf</i>
Hardware Error	Controller hardware error, turn controller ON/OFF, controller is faulty and has to be replaced	E3 <i>cr lf</i>
Write Protected Error	Unauthorized Access	E4 <i>cr lf</i>
Base Unit Error	Unauthorized Access	E5 <i>cr lf</i>



## 8.3 TCP / IP Server Interface (Java)

This is the standard communication interface. In this chapter only a listing of available commands is presented. For the full documentation refer to the manual provided with the driver software. Deviation between this listing and the driver manual may be possible due to additional features or recent updates to the driver.

### 8.3.1 Main Commands

- STX2Activate
- STX2Deactivate
- STX2Reset
- STX2ReadActualClimate
- STX2WriteSetClimate
- STX2ReadSetClimate
- STX2ActivateShaker
- STX2DeactivateShaker
- STX2ReadSetShakerSpeed
- STX2SwapIn
- STX2SwapOut
- STX2Lock
- STX2UnLock
- STX2AbandonAccess
- STX2ContinueAccess
- STX2GetSysStatus
- STX2ServiceReadBarcode
- STX2Inventory
- STX2ServiceMovePlate

### 8.3.2 Additional Commands

- STX2LoadPlate
- STX2UnloadPlate
- STX2IsOperationRunning
- STX2ReadErrorCode
- STX2SoftReset
- STX2ReadUserDoorFlag
- STX2ReadShovelDetector
- STX2ReadXferStationDetector1
- STX2ReadXferStationDetector2
- STX2BeeperOn
- STX2BeeperOff
- STX2ReadBarcodeAtTransferStation

## 8.4 StoreX Network Communication

### 8.4.1 Client Socket example (C#)

#### *Client Socket class*

```

public class StateObject
{
    public Socket workSocket = null;
    public const int BufferSize = 256;
    public byte[] buffer = new byte[BufferSize];
    public StringBuilder sb = new StringBuilder();
}

public class AsynchronousClient
{
    private Socket client;

    // The port number for the remote device.
    //private const int port = 3336;

    // ManualResetEvent instances signal completion.
    private ManualResetEvent connectDone = new ManualResetEvent(false);
    private ManualResetEvent sendDone = new ManualResetEvent(false);
    private ManualResetEvent receiveDone = new ManualResetEvent(false);

    // The response from a remote StoreX Server.
    private String response = String.Empty;

    public Socket getSocket()
    {
        return client;
    }

    public void StartClient(String STXIPAddress, int STXport)
    {
        // Connect to a remote device.
        try
        {
            // Establish the remote endpoint for the socket.
            IPEndPoint ipHostInfo = Dns.Resolve(STXIPAddress);
            IPAddress ipAddress = ipHostInfo.AddressList[0];
            IPEndPoint remoteEP = new IPEndPoint(ipAddress, STXport);

            // Create a TCP/IP socket.
            client = new Socket(AddressFamily.InterNetwork,
                               SocketType.Stream, ProtocolType.Tcp);

            // Connect to the remote endpoint.
            client.BeginConnect(remoteEP,
                               new AsyncCallback(ConnectCallback), client);
            connectDone.WaitOne();
        }
        catch (Exception e)
        {
            Console.WriteLine(e.ToString());
        }
    }

    public void StopClient()
    {
        // Release the socket.
        client.Shutdown(SocketShutdown.Both);
        client.Close();
    }

    private void ConnectCallback(IAsyncResult ar)
    {
        try
    
```

```

{
// Retrieve the socket from the state object.
Socket client = (Socket) ar.AsyncState;

// Complete the connection.
client.EndConnect(ar);

Console.WriteLine("Socket connected to {0}",
client.RemoteEndPoint.ToString());

// Signal that the connection has been made.
connectDone.Set();
}
catch (Exception e)
{
Console.WriteLine(e.ToString());
}
}

private void Receive(Socket client)
{

try
{
// Create the state object.
StateObject state = new StateObject();
state.workSocket = client;

// Begin receiving the data from the remote device.
client.BeginReceive( state.buffer, 0, StateObject.BufferSize, 0,
new AsyncCallback(ReceiveCallback), state);
}
catch (Exception e)
{
Console.WriteLine(e.ToString());
}
}

private void ReceiveCallback( IAsyncResult ar )
{

if (!this.client.Connected) return;

try
{
StateObject state = (StateObject) ar.AsyncState;
Socket client = state.workSocket;

int bytesRead = client.EndReceive(ar);

if (bytesRead > 0)
{

// There might be more data, so store the data received so far.

state.sb.Append(Encoding.ASCII.GetString(state.buffer,0,
bytesRead));

// Get the rest of the data.

client.BeginReceive(state.buffer,0,StateObject.BufferSize,
0,new AsyncCallback(ReceiveCallback),
state);

response =
ncoding.ASCII.GetString(state.buffer,0,bytesRead);

Console.WriteLine("Received from STX: "+response);
receiveDone.Set();
}
else
{

// All the data has arrived; put it in response.
if (state.sb.Length > 1)
{
response = state.sb.ToString();
}
}
}
}
}

```

```

        }

        // Signal that all bytes have been received.
        receiveDone.Set();
    }
}
catch (Exception e)
{
    Console.WriteLine(e.ToString());
}
}

public String Send(String data)
{
    response = "";

    // Convert the string data to byte data using ASCII encoding.
    byte[] byteData = Encoding.ASCII.GetBytes(data);

    // Begin sending the data to the remote device.
    client.BeginSend(byteData, 0, byteData.Length, 0,
        new AsyncCallback(SendCallback), client);

    Console.WriteLine("Sent STRING to STX server: "+data);

    Receive(client);
    receiveDone = new ManualResetEvent(false);
    receiveDone.WaitOne();

    return response;
}

private void SendCallback(IAsyncResult ar)
{
    try
    {
        // Retrieve the socket from the state object.
        Socket client = (Socket) ar.AsyncState;

        // Complete sending the data to the remote device.
        int bytesSent = client.EndSend(ar);

        Console.WriteLine("Sent {0} bytes to server.", bytesSent);

        // Signal that all bytes have been sent.
        sendDone.Set();

    }
    catch (Exception e)
    {
        Console.WriteLine(e.ToString());
    }
}
} // End of Socket's client class

```

## 8.4.2 Using a Client Socket

```
String STXId = "STX";
String STXAddress = "192.168.1.1";
int STXPort = 3336;

AsynchronousClient STXSCK = new STX_TCP_Client.AsynchronousClient();
STXSCK.startClient(STXAddress, STXPort);
String ResActivate = STXSCK.Send("STX2Activate("+STXId+")"+(char)13);
if ((ResActivate == "1;1") || (ResActivate == "1"))
{
    MessageBox.Show("Device is initialisd!", "1", MessageBoxButtons.OK,
        MessageBoxIcon.Information);
}
else
{
    MessageBox.Show("Initialisation Error!", "1", MessageBoxButtons.OK,
        MessageBoxIcon.Error);
}

STXSCK.stopClient();
```

## 9. Utility Software

LiCONiC R&D  
C.G.Malin

01-06-96  
09:04:01

HBI-UserSoft \* V 0.04, 25.05.96

---

Heraeus AG	HBI 2001-3
UserName	S-Nbr

Direct Commands	1
Monitor Flags	2
Macros	3
Teach Positioning Times	4
Random Positioning	5
Random Access Cycles	6
Random Fast Access	7
Quit	0

---

Enter [0..7]

—

### 9.1.1 Direct Commands

Direct entering of commands (ASCII-Characters) and sending to the Handling Controller. The commands can be entered as capital letters or Prompt entries by Return.

Enter direct commands to KV-PLC, press q to quit

—

## 9.1.2 Monitor Flags

P0	0000	Rot.EN	0500		
Pn	0001	GateEN	0501		
GtClse	0002	GateEN	0502		
GtOpen	0003	Rot.Dir	0503		
	0004	GtTmOut	0504		
F.Door	0005	AccsLED	0505		
SW 2E0	0006				
SW 2E1	0007				
SW 2E2	0008				
SW 2E3	0009				
Accs.	1100				
Key Valid					
InPos					
Ready	1915				
RotPos.	DM01	Accs.	DM00	AccV.	DM02
SetSpd.	DM91	aSlpe.	DM92	bSlpe.	DM93
				intvl.	DM94
—					

Status Flag of the Handling Controller. The status message “0” means inactive, the status message “1” means active.

Code	Status Flag	Comment
P0	0000	0-initiator of carrousel
Pn	0001	Position-initiator of carrousel
GtClse	0002	Gate closed switch
GtOpen	0003	Gate opened switch
KeySw	0004	Key switch
Gn LED	0005	Green LED
SW 2E0	0006	Manual positioning switch bit0
SW 2E1	0007	Manual positioning switch bit1
SW 2E2	0008	Manual positioning switch bit2
SW 2E3	0009	Manual positioning switch bit3
Accs.	1100	Carrousel access (remote or manual)
Key Valid		Manual positioning switch valid
Ready	1915	Ready-Bit
Rot.Pos.	DM1	Actual carrousel position
Access.	DM0	Carrousel set position
AccV.	DM2	Access accepted

### 9.1.3 Macros

Sending of complete, preprogrammed command sequences.

Function	Command	Key
Rot. Position	WR DM0 x	1..9
Enable Rotation	WR DM0 0	0
Gate Open	ST 1901	O
Gate Close	ST 1902	C
End Access	ST 1903	E
Shaker ON	ST 1907	S
Shaker OFF	RS 1907	F
CarAct ON	ST 1801	A
CarAct OFF	RS 1801	D
Command Reset	ST 1900	R

Quit -- esc  
Ready [1915]

Please Select -> \_

Code	Comment
0	No access, carrousel rotation enabled
1.9	Position carrousel
O	Gate open (only when carrousel is positioned)
C	Gate closed
R	Reset Handling Controller
Q	Exit macro menu
Accs. Ready	Carrousel access (remote or manual) Ready-Bit

### 9.1.4 Teach Positioning Times

Program to measure positioning times of the carrousel.

The program starts positioning automatically. As a result a table containing the measured positioning times is presented.



### **9.1.5 Random Positioning**

Program for positioning the carousel randomly without gate movements.

After entering the access intervals the program continuously simulates accesses at random positions until the “q-Key” is pressed. As a result a table containing statistical data is presented.

If an error of positioning time larger then 0.4 seconds compared with the calibrated positioning time is observed a positioning error is assumed and monitored.

### **9.1.6 Random Access Cycles**

Program for positioning the carousel randomly including gate movements.

After entering the access intervals the program continuously simulates accesses at random positions until the “q-Key” is pressed. As a result a table containing statistical data is presented.

If an error of positioning time larger then 0.4 seconds compared with the calibrated positioning time is observed a positioning error is assumed and monitored.

### **9.1.7 Random Fast Access**

Program for positioning the carousel randomly including combined positioning-gate movements commands.

After entering the access intervals the program continuously simulates accesses at random positions until the “q-Key” is pressed. As a result a table containing statistical data is presented.

If an error of positioning time larger then 0.4 seconds compared with the calibrated positioning time is observed a positioning error is assumed and monitored.

## 10. Troubleshooting

The following list shows the possible errors of a StoreX handler which can be fixed by the customer. If the steps below aren't successful, please contact an authorized service personnel.



**CAUTION !**

- Never touch electrical connections as long the Handler is connected to the external net or one or more covers are removed.
- If work with the lift assembly or inside the climate chamber is required always disconnect the mains.

Error	Cause	Action
Instrument does not power-up, green light of the Power Switch is off	Main Switch at the rear side of the instrument is turned off Fuse burned	Turn Main Switch on Replace Fuse(s)
Handler doesn't react on external commands	A fault in the electrical connectors/cables No communication to Null-Modem Internal error	Check handling RS232/V24 plug and 9pol. cable of PC to Null-Modem Set up or check the correct communication with single comments. Call service personnel
Handler doesn't react at all	No connection Fuse damage Error in electrical connection between Null-Modem and external net Belt is displaced Internal error	Check Voltage setting and ON/OFF switch Check fuse and in case of damage replace it (2AT) Check each connection point of the 25pol. cable: at external connector cable and null modem Check belt for damage and put it into the right position again Call service personnel

# 11. Maintenance

## 11.1 Maintenance Guidelines

Handler 4 can only be used in a clean and dust free environment (laboratory use). Dust can damage the open rotating parts. If the instrument is stored in a dusty, unclean atmosphere for a long period of time, the dust must be removed and the instrument must be cleaned very carefully before the instrument is installed. Caution! There will be parts in need of new grease.

The Handler 4 is constructed for minimal maintenance and with the exception of the periodic control of belt tension, there is no need for regular service.

The lift assembly requires regular but minimal check-up and maintenance. Scheduling of maintenance is dependant on the frequency of movement. Maintenance involves inspection of the lubrication of the gears, **mark of oil-filling** in the lift assembly and of play in the gears.

		Check		Maint.		Replace	
		Mo.	Mov.	Mo.	Mov.	Mo.	Mov.
Lift assembly	<ul style="list-style-type: none"> <li>Lubrication film over the entire length of the lift rails</li> <li>Free of particles</li> <li>Must not indicate wear</li> <li>Remove old lubrication film</li> <li>Apply new lubrication film</li> <li>Play of the vertical lift guidance means parts need to be changed</li> </ul>	2	20000	6	50000	--	--
Shovel Guidance	<ul style="list-style-type: none"> <li>Check max. movement in height-play and side-play</li> <li>Lubrication film over the entire length of the linear-guidance</li> <li>Free of particles</li> <li>Remove old lubrication film</li> <li>Apply new lubrication film</li> <li>Too much play in the linear guidance means parts need to be changed</li> </ul>	2	20000	6	50000	--	--
Turn Drive Belt	<ul style="list-style-type: none"> <li>Check for wear</li> <li>Check belt teeth for cracks</li> <li>Check belt metal core for free metal parts</li> </ul>	2	20000	6	50000	12	--
Climate Chamber Cleaning	<ul style="list-style-type: none"> <li></li> </ul>						
Condenser Cleaning	<ul style="list-style-type: none"> <li></li> </ul>						

Defrost	•						
Front Door Sealing	<ul style="list-style-type: none"> <li>• Check for wear on the belt</li> <li>• The edge of the belt may not indicate wear</li> <li>• The fabric of the belt should not be visible</li> <li>• Tighten the belt</li> </ul>	2	--	6	--	12	--
Gate Sealing	•						
Front Panel Sealing	•						
Glass Door Sealing	<ul style="list-style-type: none"> <li>• Check for wear on the belt</li> <li>• The edge of the belt may not indicate wear</li> <li>• The fabric of the belt should not be visible</li> </ul>	2	--	6	--	12	--

## 11.2 Removal of StoreX Handling

The StoreX Handling can be removed from the climate chamber for cleaning and servicing purposes. The removal / installation procedure includes

- Removal of Stackers from Climate Chamber
- Securing Lift
- Removal of three handling attachment screws
- Removal of Handling Plug on the inner side of Climate Chamber
- Removal of two temperature sensors on the rear side of the Lift Tower
- Careful removal of the handling from the Climate Chamber

**For re-installation of the handling follow the steps above in reverse order.**

Beware: after removing the handling from the Climate Chamber, the Handling has to be re-aligned. Great care must be taken that all moving parts and cables of the Lift Assembly move freely without obstacle. Note that the above procedure requires mechanical skills. Improper operation may harm and/or damage the instrument. Please call LiCONiC Customer Service for additional information or customer training.



### CAUTION !

- Although the entire StoreX handling may be removed for cleaning and servicing it is recommended that the service company be called in for assistance.

## 11.3 Lubrication of Handling Components

For lubrication of the radial-lead there is a lubrication-hole on the front side of the **Laufwagen**. Put lubrication in the lubrication-hole until it floods the sealing on the side.

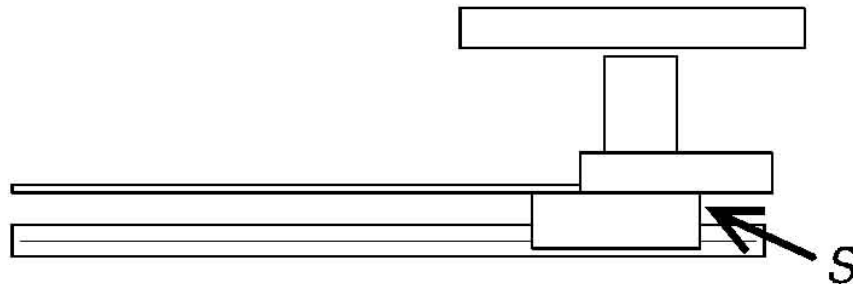

For the Lift assembly lubricate at A, B as shown below. Make sure that the lubricant covers the entire length of the linear-guidance. Use acid-free grease only. For the gears special lubrication products are needed. Lubricate C,D,E as shown below. Lubrication **toothbar** F and gears G.

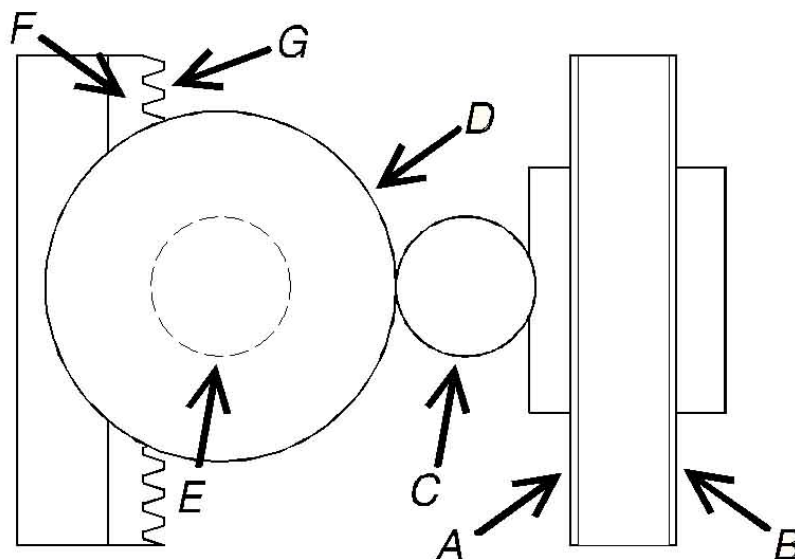

## 11.4 Cleaning

If parts are contaminated, you can easily clean them with an ordinary disinfecting cleaner. Always remove old lubrication on external parts and replace it with a new lubrication film.



### CAUTION !

- To clean instrument surfaces (e. g. Rotating Plate, Stackers etc.), always turn off the power by switching of the workstation.
- Strong detergents might dissolve casing surface coating

Alcohol:  
Casing  
Stackers  
Scanner output window

Use Ethanol, 2-Propanol or Isopropanol  
Alcohol  
Alcohol, acetone  
Alcohol  
Bar Code Scanner

## 11.5 Bar Code Scanner



**WARNING !**

Laser Class 2.  
Clean the Laser Beam Output Window only when the laser beam is deactivated.

The Laser Beam Output Window must be perfectly clean at all times. Even slight soiling will cause reading errors.

Daily Maintenance:

Clean the Laser Beam Output Window thoroughly.

Use soft material and alcohol to clean the window. Avoid any abrasive substances

## 11.6 Lubrication

Before applying any lubricant, clean parts to be lubricated thoroughly with a lint free tissue.

### 11.6.1 Lubricants

Use one of the following lubricants (DIN 51 825 KP2K) for Lift Guide, Lift Rack and Shovel Guide:

- KLUBER Paraliq GA351
- SHELL Retinex A
- Mobil Savavex Grease L2



**CAUTION !**

➤ Too much grease will cause malfunctioning of the instrument and/or contaminate liquids in the microplate.

## 11.7 Belt Tension

To check the correct tension of the Turn Drive belt, set machine under power. Move the Shovel into a Stacker and check the clearance of the Shovel to the Stacker back. The Shovel should not touch the Backbone of the Stacker.

## 12. Technical Data

### 12.1 Mechanics

- Slots (Standard config.) 2 MTP-Positions, max. load 5 kg
- Levels 22, usable height / level 17mm
- Lift drive Stepper Motor, bipolar, micro-stepping mode
- Shovel drive DC-Motor
- Gate Linear movement, heated
- Noise <52dBA / 1m
- RAL Color

### 12.2 Electronics

- Mains 115 / 230VAC, 50/60Hz (STX-IC)
- Main fuse IEC 60127 type fuse, Time Delay, Rated 5A for 230V; 10A for 115V
- Power-Supply Handling 24V=, max. Power Consumption 70W, Communication via RS-232  
2=Controller RX, 3=Controller TX, 5=GND  
7,8 and 4,6 shortended
- Gateheater 24VDC

### 12.3 Pneumatics

- Optional Gas Pressure <4 bar

### 12.4 Overall Dimensions

StoreX 40 BT

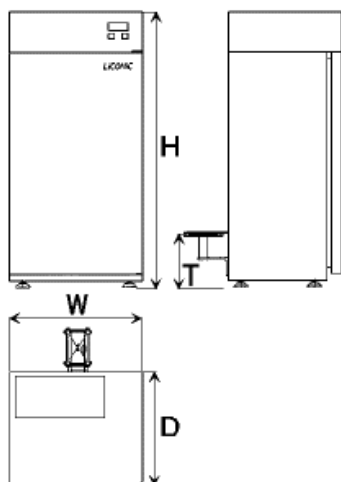

### StoreX 200 SA



### StoreX 1000 (STX / BMX)

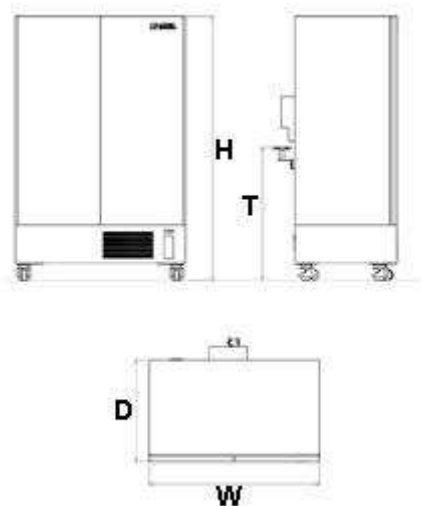

	StoreX 40		StoreX 200	
	Stand Alone	Bench Top	Stand Alone	Bench Top
Width (W)	486 mm	486 mm	744mm	744 mm
Depth (D)	514 mm	412 mm	716 mm	716 mm
Height (H)*	1223 mm	1180 mm	1223 mm	1180 mm
Transfer Height (T)	1000 mm	200 mm	1000 mm	200 mm

	StoreX 1000 (STX / BMX)	
	Stand Alone	
Width (W)	1280 mm	
Depth (D)	868 mm	
Height (H)*	1988 mm	
Transfer Height (T)	~1000 mm	

\* add 20-35mm for feet



## 12.5 Weights

	StoreX 40	StoreX 200
StoreX complete with stackers	105 kg	436 kg
Stacker, empty		
Packed and ready for shipping	176 kg	452 kg

	StoreX 1000 (STX / BMX)
StoreX complete with stackers	XXX kg
Stacker, empty	
Packed and ready for shipping	XXX kg

## 12.6 Ambient Ratings

Operating:      Temperature:      20 – 26°C / 68 – 79°F  
    Relative humidity:      45% or below (non- condensing)

Storage:      Temperature:      10 – 40°C / 50 – 104°F  
    Relative humidity:      50% or below (non- condensing)

Indoor use

Altitude up to 2'000m

Mains Supply voltage fluctuations up to –5% to +5% of nominal voltage.

Mains Overvoltage category II.

Pollution degree 2.

# 13. Appendix

## 13.1 Decontamination instructions

Prior to repairing or servicing the instrument or parts, shipping it to the distributor or manufacturer, the instrument or affected parts must be thoroughly decontaminated and a copy of this form should be filled out and enclosed with the instrument/parts..

\*

I hereby declare that the contents of this package have never been exposed to hazardous biological and/or radioactive material or that such parts have been decontaminated or disinfected to remove or inactivate any biological and / or radioactive material which could be dangerous to service personnel.

Instrument Type: ..... Serial No.: .....

Parts:

- .....
- .....
- .....
- .....

Name: .....

Function: .....

Company: .....

Address: .....

.....

.....

Country: .....

Date of Decontamination: .....

Type of Disinfectant used: .....

.....

Date: .....

Signature: .....